

# Alarm Lock

The Access Control Lock Solutions trusted by more schools & universities, corporations, retail chains & healthcare providers

- standalone • wireless network • enterprise class



**ALARM LOCK**

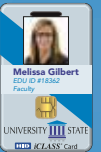

- TRIOLOGY T2 STANDALONE CYLINDRICAL DIGITAL PIN CODE LOCKS .....2
- TRIOLOGY AUDIT TRAIL/PC-PROGRAMMABLE PUSHBUTTON LOCKS .....3
- TRIOLOGY PROX LOCKS WITH HID PROX ID CARD READERS .....4
- TRIOLOGY DOUBLE-SIDED PIN CODE AND PIN/PROX STANDALONE LOCKS .....5
- TRIOLOGY STANDALONE LOCKS FOR PRIVACY AND SPECIAL APPLICATIONS .....6
- TRIOLOGY HIGH SECURITY STANDALONE MORTISE LOCKS .....7
- TRIOLOGYEXIT ADDS AUDIT TRAIL AND AUTO LOCK/UNLOCK TO PANIC EXITS .....8
- TRIOLOGY NARROW STILE TRIM FOR ALL GLASS/ALUMINUM DOORS AND PANIC EXIT DOORS ..... 9-10
- MATCHING TRIOLOGY DIGITAL PIN & PROX ACCESS 12/24V KEYPADS WITH AUDIT TRAIL .....11
- TRIOLOGY AUDIT TRAIL AND PROGRAMMING ACCESSORIES, FINISHES AND ORDERING INFORMATION .....12
- TRIOLOGY NETWORKX WIRELESS 802.11/ETHERNET LOCK ACCESS SYSTEMS ..... 13-15
- WIRELESS NETWORKX KEYPADS & NETPANEL ..... 16-17
- ARCHITECH DESIGNER WIRELESS ACCESS CONTROL LOCKING PLATFORM ..... 18-21
- SIRENLOCK EXIT ALARMS: WATERPROOF, INTERIOR, AND DELAYED EGRESS .....22
- REMOTE RELEASE MAG LOCKS, POWERMAGS AND RTES .....23
- ADVANCED DOOR ALARMS .....24
- ESSENTIAL ADD-ONS AND EXTRAS .....25
- TRIOLOGY FAMILY OF ACCESS PRODUCTS CHART ..... 26-27
- K-12 AND CAMPUS LOCDOWN SOLUTIONS .....28
- RETAIL LOCKSMITHS PROFIT CENTER PROGRAM .....29

Trilogy: The leading electronic access locks





# Trilogy:®



hospital



retail



airport



schools



pharmacy



office



### Retrofit Any Knobset

DL2700 Trilogy® T2 Grade 1 standalone digital cylindrical keyless door lock, fingertip programmable - New Remote Release Retrofit Kit, too.  
page 2



### Audit Trail

DL2800/DL3000 Trilogy audit trail cylindrical security locks with PC Programming & Schedules  
page 3



### ID Card Access

PDL3000 Trilogy HID® Reader/Enroller Prox Lock with audit trail  
page 4  
+ New iClass/One-Card Model PDL7100  
page 15



### Vandalism Protection

PL3000 Prox-only vandal proof lock  
page 4

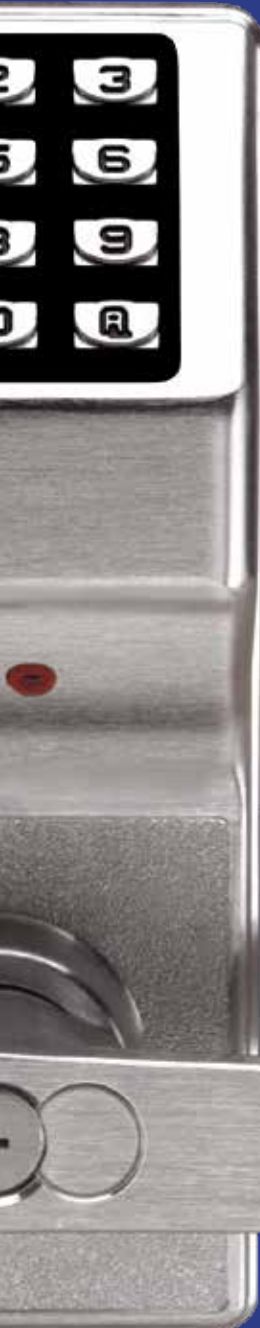

### Airport Jetway Use and more

DL/PDL5300 Dual sided PIN/prox lock with audit trail  
page 5



### Communicate Wirelessly

Trilogy Networkx™ communicate wirelessly via Ethernet or 802.11 now including Networkx Keypads & Controller plus Exit Trim  
DL/PDL6100, DL/PDL6500, NET-DKPAK, NET-PDKPAK, NETPANEL, ETDLN/ETPDN  
page 13-17



### Restrooms/Classrooms

DL/PDL4100, DL/PDL4500 Trilogy Privacy/Lock Down Pushbutton -for restrooms, on-call rooms, file rooms, fitting rooms, classrooms  
page 6



### High Security PIN/Prox ID

DL3500, PDL3500 Trilogy high security mortise locks and keyless gate locks with and without prox  
page 7



### Glass/Aluminum Doors

DL1200, DL1300, PDL1300 Trilogy Narrow Stile Pushbutton aluminum door trim latch locks for PIN or Prox ID card access  
page 9



### Exit Doors

ETDL, ETPDL TrilogyExit retrofits existing exit bars and saves manpower on guard tours  
page 8

### Glass & Standard Pushbar Doors

DL1200, DL/PDL1300ET TrilogyExit keyfree convenience and greater security for panic exit devices on standard & narrow stile aluminum frame glass doors  
page 8 & 9

All Trilogys feature no fee/license FREE Windows-based software



### Access Keypads

DK3000 & PDK3000 Trilogy Matching Weatherproof PIN/Prox. ID Access Keypads with audit trail  
page 11

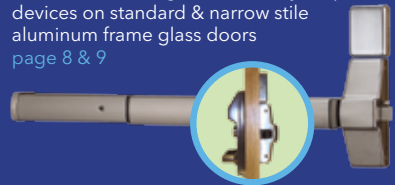

### Architech Series Locks

Designer Wireless Access Control Systems  
page 18-21

Keyless access locks trusted by more leading retailers, firms, hospitals, schools & airports

# Trilogy T2: Electronic cylindrical digital locks



## Trilogy® T2 standalone digital cylindrical lock

### DL2700 Series

Our most popular lock - now with more codes & power!

- More codes: up to 100 3-6 digit codes: 1 master, 10 managers, 90 basic users, 3 one time service codes
- 5AA battery operated; 200,000 cycles, typical
- For outdoors, specify **WP** weatherproof models -31° to +151°F (-35° to +66°C)



ADA-compliant levers



Curved regal handle option for all Trilogys

Lever sets feature clutch mechanism ensuring longer life and complies with ADA specs providing barrier-free access to the disabled.

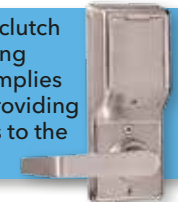

New! Retrofit Remote Release for Trilogy & Networx

Field-proven Trilogy® electronic standalone pushbutton locks available in cylindrical, mortise and trim models to retrofit with panic exit bars or narrow stile aluminum/glass doors' latch locks

### Trilogys feature:

- In an hour, add dependable wireless access control, one door at a time—easily retrofit standard knobsets
- Support 100 to 2000 PIN codes (3-6 digits); some with built-in HID prox readers for use with access ID cards/fobs
- Multi-level user codes & one-time service codes. Free passage, group- or total lock-out modes, too
- All are fingertip programmable at vandalproof all-metal keypad
- PC programmable models also feature printable audit trail, auto-lock/unlock scheduling saving guard/manpower costs
- Longer-life battery operation – 200,000 cycles typical (cylindrical models use 5AA off-the-shelf batteries); low battery alert
- Key override, standard core (supplied) or interchangeable core prep
- Non-handed cylindrical models
- Programmable relay functions
- Durable BHMA Grade 1 cylindrical Lockset
- Weatherproof models -31° to +151°F (-35° to +66°C)
- Curved Regal handle option
- Choice of 3 Architectural finishes (US3 polished brass, 26D satin chrome, 10B duronodic)

**Retrofit Trilogys into Wireless Networx, too (see pg 8)**

Add Remote-Release convenience to any cylindrical Trilogy installation with keyfobs or desk-mounted button

- Easy & Cost Effective
- Retrofits Cylindrical Trilogy Locks dating all the way back to 2000 (with a serviceable battery pack) :RR-TrilogyKit
- For Networx Locks, too! Just purchase either the keyfob (shown above left) or desk-mount release button (pg 8)



**NEW!**  
Remote Release



Ideal for receptionists.

# Trilogy T3: Choice of audit trail pushbutton locks

## T3 advanced digital lock with audit trail

### DL3200 Series

#### High Capacity Audit Trail Lock

New, enhanced version of the original DL3000

- 2000 user codes (3-6 digits)
- Multilevel security - Master; manager; supervisor; basic users
- Program at keypad or with PC-and/or data-transfer module
- 40,000 event audit trail logs with time-/date-stamp of access by user; create PC reports or at hand-held wireless printer
- 500 scheduled lock/unlock events
- Quick passage mode (without being in program mode)
- Weatherproof -31° to +151°F (-35° to +66°C)
- 5AA Battery operated; 80,000 cycles, typical

### DL3000

Original Audit Trail Trilogy, similar to above

- 300 multilevel user codes; 1600 event log
- 150 scheduled lock/unlock events
- For outdoors, specify **WP** weatherproof models -31° to +151°F (-35° to +66°C)



## Trilogy economical audit trail lock

### DL2800

#### Cylindrical Lock

- 1000 event audit trail log, time-stamped by day, date, time and user
- 150 scheduled automatic lock/unlock events, etc.
- 200 user codes: Master, manager, supervisor and basic users. Also one-time service code (3-6 digits)
- Weatherproof -31° to +151°F (-35° to +66°C)
- 5AA Battery operated; 80,000 cycles, typical

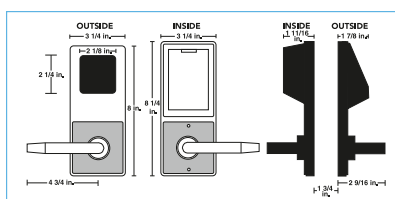

Trilogy cylindrical locks retrofit standard knobsets simply, in about an hour





# Prox ID card support: With Trilogy durability



## Trilogy prox lock with audit trail

### PDL3000

#### PIN/Prox Cylindrical

- Use the same ID cards as hardwired access systems & install in an hour
- Save all the downtime and 1/2 the cost of hardwired systems
- Provide access for up to 2000 users, with prox ID-cards or 3 to 6 digit codes including:
  - Master, manager, supervisor and basic user. Users are individually programmed to use a card only, code only, or, for the highest security, both card and code.
- Built-in HID Prox reader for entry with HID125KZ prox ID cards and keyfob credentials
- Grade 1 BHMA Certified durability and rugged clutch mechanism ensure long dependable life
- Weatherproof performance for indoor and outdoor applications, wide operating temperature range of -31°F to +151°F (-35°C to +66°C)
- Electronic master key system with access customized to each user's hours - Give each user access to common areas and/or their individual area(s) and do so defined by the actual times they are permitted entry there.
- Tap and Add batch ID card enrollment mode at lock or download from a PC
- 40,000 event audit trail; 500 scheduled events
- PC programming/reporting

- Quick passage mode
- 5AA battery operation; 60,000 cycles, typical

**For iClass Prox Locks with 13.56 MHz support for one-card solutions - also see PDL7100 pg 8**

**PDL3000K** – Model also logs mechanical key override use

## Trilogy prox only defeats vandals

### PL3000

#### Prox Only Cylindrical

- Keypad-less version of above for ultimate vandal-proofness in harshest environments
- Accepts HID prox cards and keyfobs for access
- Easy Tap & Add batch ID card enrollment mode allows many cards to be quickly added without PC –also- downloadable from PC or enroller tool
- 40,000 event audit trail log, 500 scheduled events
- PC programming/reporting

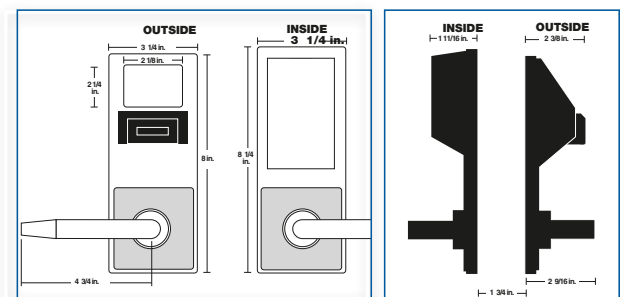

# Double Sided: Access on both sides of the door



*A favorite solution for airport jetways!*



## Double-sided Trilogy for keypad PIN-code access on two sides of door

### DL5200

- Incorporates all of the important features of DL2700 (T2) into a double-sided lock
- Easy to add, delete, change users at the keypad
- Programming user codes on one side of the door works both sides, cutting your time & labor in half
- Ideal for community pool gates, courtyard gates, airport jetway doors, interrogation rooms, psych wards
- Comes with LED & audible entry indicators
- 100 user codes (3-6 digit codes)
- Standard prep & IC models available
- Weatherproof -31° to 151°F (-35° to +66°C)
- 5AA batteries operated, 80,000 cycles, typical

### DL5300/PDL5300

- 2000 user codes (3-6 digits) and/or accepts HID prox cards and keyfobs (prox model PDL5300)
- Direction-specific access assignable per user programmable access for each user for one or both sides of the door
- Up to 40,000 event audit trail log, time-stamped by day, date, time and user (PC or data module reportable)
- 500 scheduled events, including 4 quick schedules
- Data port for programming lock and querying audit trail is on primary side of door, along with functioning mechanical key override
- 4 programming levels, 4 user groups
- 5AA battery operated; 60,000 cycles, typical



Note: Key override operates latch only from primary side.

PDL5300 model features 2 built-in HID prox card ID readers on both sides.

# Trilogy 4100/4500: Privacy & lock-down features



Standard Cylindrical Model with privacy button (center, top) featured



Flashing LED inside and outside indicates the room is occupied or locked



Also available in mortise model



## Standalone Trilogy® locks with privacy/lock down pushbutton on inner door (mortise & cylindrical pin or pin/prox models)

### DL4100 and Prox PDL4100

#### Similar to the DL3200 features plus:

- Interior LED on the inside housing indicates when the privacy session is active
- Rest assured knowing that you are safe within the room, while locking out unauthorized users.
- 2000 PIN or PIN/Prox user codes; 500 scheduled events; 40,000 audit trail
- Privacy Pushbutton – Push button on inside door to temporarily lock-out keypad codes (programmable option)
- Occupied and multi-status LED indicator, flashes when privacy session is active
- Self-stick instructional signage, supplied (bilingual)
- Keypad or PC programming/reporting
- Right- or left-hand, classroom or deadbolt function models
- 1-3/8" mortise cylinder & ASA strike, matching function supplied, only with 4500 Series
- 5AA battery-pak operated; 60,000 cycles, typical
- 3 Architectural finishes (US3 polished brass, 26D satin chrome, 10B duronodic)
- Weatherproof -31° to +151°F (-35° to +66°C)

Mortise DL4500 and Prox Mortise PDL4500 also available

## School Lock-Down Applications: remain safely inside until the coast is clear – no need to open the door

At the first sign of trouble outside, with just one button and virtually no special training or knowledge required, faculty and/or students of all ages can simply press Trilogy's inside 'privacy' button to lock out unauthorized access, instantly locking-down a classroom or area, all while remaining safely within the room. There is no need to open the door, nor use a special key, since the fingertip-activated button is located on the inside door, i.e., the same side as classroom occupants. Trilogy's lockdown function automatically disables free passage through the door and even locks out general PIN user codes, since routine Trilogy keypad access is temporarily suspended whenever the privacy button is activated (even when the lock is time-scheduled for free-access mode).



Instantly, a *lock-down override code*, however, will reactivate the pushbutton keypad and enable authorized teachers/staff, outside the classroom, to readily bypass the lockout function at any time, should students, etc. accidentally or purposefully activate lockdown mode. (In fact, all master and management codes (11) will permit instant access to the Trilogy protected area.)

**For GLOBAL LOCKDOWN COMMANDS, activated from any lock or PC /server, also see NETWORKX pgs 6-10**



# Trilogy Mortise: High security digital locks



## Trilogy® high security mortise locks with and without prox ID readers

### DL3500 Series Mortise Locks

- 300 User codes: Master, manager, supervisor & basic users
- Fingertip or Windows PC-programmable
- Real time clock enables up to 500 scheduled events and holiday schedules
- 40,000 Event audit trail provides a printed time/date- stamped log of all electronic activity
- Long-life battery pak for 80,000 cycles, typical and low-battery alert
- Choose either classroom or deadbolt versions and left or right handing (If reverse hand is required, lock is field reversible.)
- 1 3/8" (3.5 cm) mortise cylinder supplied card enrollment mode allows many cards to be quickly added without PC –also– downloadable from PC or prox enroller tool
- 40,000 event audit trail log
- 500 scheduled events, e.g., lock or unlock
- PC programming/reporting
- Quick passage mode (without being in program mode)
- Program data transferred to lock via AL-PCI2 or AL-DTMIII
- 5AA battery-pak operated; 75,000 cycles, typical
- 3 Architectural finishes (US3 polished brass, 26D satin chrome, 10B duronodic)
- Weatherproof -31° to +151°F (-35° to +66°C)

### PDL3500 Series

#### PDL3500 Series mortise lock with built in HID prox reader, similar to DL3500 Series, but with:

- 2000 user codes (3-6 digits) and/or HID prox cards/fobs
- Multilevel security - Master; manager; supervisor; basic users
- Easy Tap & Add batch prox ID card enrollment mode allows many cards to be quickly added without PC –also– downloadable from PC or prox enroller tool
- PC programming/reporting
- Quick passage mode (without being in program mode)
- Program data transferred to lock via AL-PCI2 or AL-DTMIII
- 5AA battery-pak operated; 75,000 cycles, typical
- 3 Architectural finishes (US3 polished brass, 26D satin chrome, 10B duronodic)
- Weatherproof -31° to +151°F (-35° to +66°C)

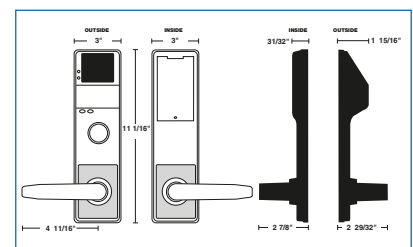

Cylindrical Models DL4100 and Prox/PIN Lock PDL4100 Versions also available

# TrilogyExit: Add audit trail to panic exits

Add Trilogy convenience, programming, flexibility and audit trail to panic exit devices from most major manufacturers



## OUTSIDE:

Rugged, field-proven Trilogy digital lock.

## INSIDE:

Existing panic exit device – Most major brands supported



Add Trilogy convenience, programming, flexibility and audit trail to panic exit devices from most major manufacturers

### TrilogyExit

- Clutch Mechanism insures long life and durability
- Fingertip and/or Windows Programmable
- 2000 User Codes: Master, manager, supervisor and users
- Real Time Clock for up to 40,000 Event Time/Date-Stamped Audit Trail
- Up to 500 Lock/Unlock Schedules (with Time Zone Support)
- Rugged 12-Button Metal Keypad
- Non-Handed; Fully Field Reversible
- Adaptable to most major manufacturers of standard RIM and IC RIM Cylinders
- Supports most panic exit devices including: Von Duprin 99, Corbin ED5000 & Yale, Dorma 9300, Arrow 3800, Old Style Sargent, New Style Sargent, Precision 1100, Cal Royal 9800
- Battery operated; uses 5 AA batteries

**Also available in prox model for added convenience and security. Includes all of the features above plus:**

- Accepts most HID Proximity cards and keyfobs
- Users are individually programmed to use a card only, code only, or for highest security – both card and code
- Prox card data can be added to software by uploading from lock, by using AL-PRE or entering directly from computer using DL-WINDOWS software.

**Also available in prox only model (ETPL)**

# Trilogy Narrow Stile: Glass door retrofit

Now get convenient keyless PIN code or Prox access anywhere there's a glass door.

Trilogy Narrow Stile lever models (left and right) designed to work with Adams Rite® latch series; Thumbturn models (shown at center) support swing & hook bolt products .

Plus, PC-programmable 1300 Series models provide audit trail log of door users.



## Pushbutton aluminum door trim retrofit glass doors with latch locks

### DL1200, DL1300

- Add keyless convenience to mechanical latch locks from Trilogy's all-metal, vandal-resistant 12-button keypad and/or automatic timed-scheduled locking/unlocking and audit trail with 1300 Series
- Aluminum door retrofit outside trim for Adams Rite® 1850, 1950, 4710, 4070, 4730, 4900 Series and MS1850S and MS1950S Series latch locks
- DL1200 supports 100 3-5 digit PIN user codes, fingertip programmable
- DL1300 (and Prox PDL1300, right) support 2000 users, PC programming/reporting and features 40,000 event audit trail by user and 500 event schedule/real time clock (e.g. lock/unlock by time)
- Weatherproof -31° to +151°F (-35° to +66°C)
- Long-life, battery-operated for 100,000 and 80,000 cycles respectively, typical on 2 lithium 3V batteries, supplied; low battery alert
- Compact styling 14-3/8" H x 1-5/8" D x 1-3/4" W
- Key override mortise cylinder, 1-1/4" supplied. (Supports 1-1/8", 1-1/4" and 1-3/8"). Also interchangeable cores supported (Corbin/Russwin, Yale, Schlage, Medeco.)
- Backsets 31/32", 1-1/8" and 1-1/2"; Stile thickness 1-3/4"
- Non-handed; fully field-reversible
- Four finishes US26D satin, 10B Durondic, MS metallic silver and MB metallic bronze

## Narrow stile prox ID card PC-programmable model with audit trail

### PDL1300

Includes all of the 1300 Series features, at left:

- Built-in HID prox reader, supports up to 2000 users with HID Prox ID cards or/fobs or 3-6 digit PIN codes
- Easy Tap & Add batch prox ID card enrollment mode allows many cards to be quickly added without PC –also– downloadable from PC or prox enroller tool
- 40,000 event time-/date-stamped audit trail by user
- 500 event schedule/real time clock (e.g. lock/unlock by time)
- Long-life, battery-operated for 65,000 cycles, typical on 2 lithium 3V batteries, supplied; low battery alert



Ideal for universities, hospitals, laboratories, airports, office buildings & retailers



# Narrow Stile Exit: For aluminum door retrofits

## OUTSIDE:

Add keyless access with Trilogy dependability



Add Trilogy convenience, programming, flexibility and audit trail to panic exit devices from most major manufacturers for narrow stile glass aluminum doors



## INSIDE:

Existing panic exit device – Most major brands supported

Alarm Lock's new Trilogy narrow stile exit device trim locks

### DL1200ET

- Adds vandal-resistant keyless access to panic exit doors
- Protects storefronts and managed properties 24/7
- 100 users supported (3-5 digit codes)
- Designed with all-metal, vandal-resistant 12-button keypads
- Supports 3-6 digit PIN codes and multilevel user hierarchy
- Easily installs on most aluminum glass doors
- Works with Jackson, Dor-O-Matic, Von Duprin (Von 33 LH (RHR) only), Dorma, Arrow, DCI & Corbin panic devices (Dor-O-Matic, Jackson and Dorma devices require thumb-turn or knob Note: Must purchase separate TP assembly – See price book).

### DL/PDL1300ET

As above but also equipped with ID card prox reader (PDL version), PC programming and automatic lock/unlock scheduling and time zone support

- 2000 Users (PIN code or prox ID on PDL model)
- Two finishes 2 Architectural finishes (26D satin chrome, 10B duronodic)

### Exit Devices TP Kits (Must order TP Kit Separately)

- Jackson 1095
- Dor-O-Matic - 2090
- Von Duprin 22
- Von Duprin 33 LH (RHR) only
- Dorma - 5300
- Arrow - 51200/51250
- DCI - 1200/1300
- Corbin - ED8200

**Note** - Certain manufactures' exit devices such as Jackson, Dor-O-Matic, DCI and others require a greater degree of rotation so a knob (50) or Thumb Turn (25) is required to retract and project the latch. In this function, the latch will remain retracted until a PIN or Prox Card is represented to project the latch creating a hold back feature. please contact your local Alarm Lock representative for additional information.

# Access keypads: 12/24V AC/DC with Trilogy features



## Trilogy® weatherproof 12/24VAC/DC digital access keypads with PC programming & audit trail

### Trilogy DK3000

- 2000 PIN user codes, multilevel security
- Ideal for use with 12V or 24V (AC or DC) electric door strikes, mag locks or Alarm Lock Remote Release Mag Lock Kit (adjacent page)
- Wall mount or single gang box
- 2 High-Current Rated 8A Relays for entry, alarm zone shunting or lock release by real-time schedule
- Vandal-resistant, all metal 12-button keypad
- Keypad or PC programmable
- 40,000 Event audit trail report/print to PC or hand held printer or DTMIII Data Module
- Timed Egress Input – Selectable door open times 5, 10 or 15 seconds
- 500 Scheduled events & real time clock
- Tamper supervised (reportable to alarm system)
- Remote release feature; request-to-exit input
- Weatherproof -31° to 151°F (-35° to +66°C)

Ideal for elevators and gate applications

## Digital access keypad with prox reader

### Trilogy PDK3000

Same features as DK3000 above, plus

- Built-in HID proximity reader
- Accepts up to 2000 PIN codes and/or HID cards and keyfobs

For Wireless Keypad Solution, Ideal for use with Mags, Strikes and Electrified Exit Devices - Please also see Networx Keypad & NetPanel pgs 9-10

# Trilogy audit trail and programming

## AL-IR1 Infrared Printer

- Prints the event log and user code with hand-held convenience.

## AL-DTMIII Data Transfer Module

- Module used to transfer program data from the PC to the lock and receive Audit Trail from the lock. Can transfer program data for up to 200 locks.

## AL-PRE

- Alarm Lock Prox Reader/Enroller (For Use With Prox Lock) Prox Card Reader/Enroller Enables instant, automatic enrollment of Prox Cards into DL-Windows (just tap the Prox Card/fob device to the unit's faceplate to enroll)! Supports all prox cards and prox keyfobs. Simultaneous card enrollment, downloading or lock polling – all on just one serial port. Replaces AL-PCI. 9V Battery operation (6 mos. to 1 year, typical).

## DL-WINDOWS SOFTWARE

- Windows-format software used to create programming, manager, users and schedules, receive audit trail from lock, program the lock using PC or laptop, program the AL-DTMIII to program multiple locks and configure the AL-DTMIII to transfer data.
- Free download at [www.alarmlock.com](http://www.alarmlock.com)

## AL-PCI2 (not shown)

- Interface cable interconnects lock and PC for data transfer. (AL-PCI also includes DL-WINDOWS CD)

## AL-PCI2U, (shown) as above, with USB interface cable



# Trilogy & Networx ordering information

## Cylindrical Trilogys

**DL 27 00 WP IC /26D -Y**

### Model/Series:

DL27 = DL2700 Series  
DL28 = DL2800 Series  
DL30 = DL3000 Series  
DL32 = DL3200 Series  
DL52 = DL5300 Series  
PDL30 = PDL3000 Series  
PDL53 = PDL5300 Series

### Networx Wireless:

DL6100 PIN Series;  
PDL6100, 7100 PIN/Prox

### Trim:

00 = Lever  
75 = Regal Curved Lever

### Exterior/Interior Use:

For Exterior use of DL2700 & DL3000 only, order WP for weatherproof use. All other models are weatherproof as standard.

### Cylinder:

IC = Standard Interchangeable Core Prep for Best, Falcon, Arrow, KSP  
(Note: No "IC" indicates standard K.O. cylinder.)

### Finish:

/3 = US3 Polished Brass  
/26D = US26D Satin Chrome  
/10B = Duronodic (Special Order)

### Special Order IC Prep:

-Y = Yale  
-M = Medeco  
-R = Sargent  
-C = Corbin/Russwin  
-S = Schlage

## Mortise Trilogys

**DL 35 00 DB R /26D EX**

### Model & Series:

DL35 = Trilogy T3 Mortise Series

### Networx Wireless:

DL6500 PIN; PDL6500 PIN/Prox

### Trim:

00 = Standard Lever  
75 = Regal Curved Lever (U.S. Option Only)

### Lock Body:

DB = Dead Bolt  
CR = Class Room (U.S. Only)

### Handing:

|                          |         |
|--------------------------|---------|
| Your Door -              | Order - |
| Left Handed              | L       |
| Right Handed             | R       |
| Left Hand Reverse Bevel  | R       |
| Right Hand Reverse Bevel | L       |

### Finish:

/3 = US3 Polished Brass  
/26D = US26D Satin Chrome  
/10B = Duronodic (Special Order)

### European Model Suffix

Not Used For U.S. Models  
\*Note: Standard Lever for U.S. Models is Straight Lever. Standard Lever for European Models is Curved Tubular Lever

(Note: Trim is non-handed. Lock body is field reversible.)

# Remote Release Kit

## RR-TRILOGYKIT

- Remote release kit for all Trilogy Cylindrical models includes the RR-1BUTTON for desk mount applications and RR-RECEIVER which is designed to be installed inside the battery compartment next to the battery pack of any cylindrical Trilogy lock. The RRRECEIVER connects to the 2 white remote release wires inside the battery compartment and to the black and red battery pack wires to power the receiver. These kits will retro fit to any existing cylindrical Trilogy manufactured since 1994.



# Choice of three Trilogy finishes



US3 Polished Brass



US26D Satin Chrome



US10B Duronodic

# U.S. Handing options



00 Straight Lever



75 Regal Curved Lever



25 Turnpiece  
50 Knob available on  
DL1250/1350

Matching Trilogy & Networx Keypad models, see pgs 14 & 17

## Trilogy Narrow Style

**DL1200/26D1**

### Model Type

PDL – Prox/PIN  
DL – Digital PIN

### Trilogy Series

12 – 2700 Series  
13 – 3000 Series

### Trim

00 = Lever  
25 = Turnpiece  
50 = Knob  
75 = Regal lever

### Finish

/26D Satin Chrome  
/10B Duronodic  
/MS Metallic Silver  
/MB Metallic Bronze

### Mechanical Dead Latch

1 – Supports Adams Rite: 4710, 4730, 4900 Series  
2 – Supports Adams Rite: 4070, MS1850S, MS1850S-050, MS1950, MS1950-050  
3 – KIT Includes Adams Rite 4900 with 1-1/8" backset, 628 & 313 faceplate  
4 – KIT Includes Adams Rite 4900 with 1-1/2" backset, 628 & 313 faceplate

## Trilogy Exit

**ETPDL- 1 R/ 26D V99**

### Type:

PDL = Digital with Prox  
PL = Prox Only  
DL = No Prox  
N = (suffix) Networx Wireless

### Door Thickness:

1 = 1 3/4" + 1/8"  
2 = 2" to 2 3/4"  
3 = 3" to 4"

### Handle:

R = Regal  
S = Straight

### Finish:

/3 = US3 Polished Brass  
/26D = US26D Satin Chrome  
/10B = Duronodic (Special Order)

### OEM Trim

V99 = Von Duprin 99  
C50 = Corbin ED5000 & Yale  
D93 = Dorma 9300  
A38 = Arrow 3800  
S88 = Old Style Sargent  
N58 = New Style Sargent  
P11 = Precision 1100  
CR8 = Cal Royal 9800



# Trilogy Networkx: Wireless networking locks



**networkx**  
by Trilogy

## Wireless Trilogy Networkx™ Locks supports 802.11 or ethernet

### DL6100 & prox/PIN version PDL6100

Trilogy Networkx Locks eliminate door-to-door programming and audit trail retrieval by communicating wirelessly via Ethernet or 802.11B/G, while providing all original Trilogy standalone lock's functionality. They provide a quick, easy, economical access system with advanced features & functions, like automatic schedules, event logs and support for 2000 doors and 5000 existing Prox. ID Cards/Badges, but with no wires to run, and no access panels or power supplies to buy or install. At its simplest it's one Grade 1 durable wireless lock per door, installed in about an hour, all communicating to a single Gateway (each gateway controls up to 63 locks), networked to any non-dedicated Windows-based PC. In addition to Wireless Trilogy Networkx' unsurpassed battery-life, exceeding 5 years, they feature new network-wide capabilities, executed from any lock or the network's PC, including emergency priority global lockdown deployed in seconds, and you can activate (non-priority) system-wide free-passage or locking modes from the PC. For existing Trilogy installations, original standalone and new Trilogy Networkx locks can seamlessly share one common database hosted on free Alarm Lock DL-WINDOWS software.

- **Trilogy Networkx Locks communicate wirelessly via Ethernet or 802.11B/G** for a comprehensive wireless networked door access control system, eliminating door-to-door programming and audit trail

retrieval and providing all standalone Trilogy lock functionality plus new network-wide and emergency lockdown features

- **Unsurpassed 5-year+ battery life, typical**, (Automatic battery status reports at the PC; visual and audible low-battery status indicators at lock(s).)
- **Trilogy Networkx and gateway modules have an integral transceiver for highly-efficient 900MHz bidirectional communications**, for longer range and less interference than with more common 2.4GHz spread spectrum devices. Alarm Lock devices require NO wiring; NO splitters or repeaters; NO hardwiring to the host/server; NO extra power supplies; and NO access controller/panels.
- **In 10 seconds, activate emergency global lockdown from the Networkx PC or any Networkx lock**. (This priority emergency command is lightning-fast system-wide and supercedes all scheduled programs or updates, etc. However, if desired, locks may be selectively programmed to be excluded from emergency global lockdown function, i.e., they will ignore the command.)
- **System-wide free-passage enable or disable**, can likewise be activated from the Networkx PC
- **Locks support up to 5000 users with 3-6 digit numeric PIN codes and PDL-Series also support prox ID card users** (virtually all HID™ format proximity technology ID cards, fobs, credentials.)

- **On demand, in seconds, wirelessly change users, schedules, lock features or retrieve audit trails of up to 40,000 events/lock from any networked PC.** (Note: Transaction processing time is dependent upon system capacity, the more locks/gateways and the more data to be up/downloaded, the longer the time.)
- **Unattended programming updates or event log retrievals can be scheduled** to run automatically, saving manpower and productive time.
- **Seamless upgrade path for original Trilogy users:** Intermix with existing Trilogy standalone lock installations and share one database and familiar Trilogy lock and software functions: Trilogy Wireless Network Locks seamlessly integrate in an existing Alarm Lock Trilogy standalone door access system and share the same single DL-WINDOWS database (requires v4.1.x or higher). Existing Trilogy users can easily add one wireless Networkx Lock, or as many as two thousand, to an existing system seamlessly with no downtime.



Up to 2000 locks and a PC communicate wirelessly through bidirectional Gateways – eliminating the need for door-to-door programming and audit trail retrieval.

In seconds, global lockdown can be implemented from any Trilogy lock or the DL-WINDOWS computer.

- **Secure 128bit AES PC encryption and proprietary RF-link lock communication encryption** protects the system from interference or tampering (WEP or WPA compatible with wireless modem).
- **Remote System Management:** VPN-connection /remote capability for accessing the Networkx System and controlling up to all 2000 locks, with all the security and peace-of-mind of your IT network. (No special modems required.)
- Wireless locks are fully keypad programmable and can be up and functioning even before their wireless network is configured, so IT departments don't have to coordinate with physical security departments or locksmiths
- Free Alarm Lock DL-WINDOWS software doesn't require a dedicated computer or a special computer network or costly server software licenses, it simply runs as a secure Microsoft Windows-based application, on any computer system (as basic as a desktop or laptop PC), a wired or wireless router, and a gateway module or on an internal LAN with static IP address (recommended). MS XP and Vista supported (v4.1.x or higher).
- Minimizing hardware & installation costs, a single gateway module can interface between the PC network and up to 63 Networkx locks, with a range of up to 900' clear field range or up to 200' depending on building construction. At its maximum, a Trilogy Networkx system can comprise up to 32 gateways for the networking of up to 2000 locks or access controlled doors.
- Wall- or ceiling-mountable, compact gateway modules are available in wireless/hardwired and wired-only versions (with Power Over Ethernet (POE) option). The hybrid model connects using either 802.11, Ethernet cable or 100Base-TX (using RJ45

Jack); the wired versions use an RJ-45 Ethernet cable. Networkx communications support both wired Ethernet 10BaseT and wireless 802.11.

- For the fastest most reliable networked system, in discovery setup mode, the system will locate and DL-WINDOWS will display each lock's signal strength at each installed gateway, so you can select it and optimize reliable communications and eliminate guesswork.
- Lock programming, user- and usage-data are stored locally at the battery-powered lock for uninterrupted door access usage in a power outage or server offline situation.

#### Enterprise Networks

- Networkx locks can be used as wireless, single-door controllers in real time too
- Use with Continental Access® CA3000 or Lenel OnGuard® Integrated Access Control & Video Security Platforms



CardAccess 3000

#### Trilogy Networkx Lock Specifications:

- Weatherproof locks for indoor/outdoor use with wide operating temperature range (-31 to 151° degrees F).
- Cylindrical models boast industrial strength BHMA Grade 1 durability and all models feature vandal-resistant all-metal keypad for PIN codes.
- PDL6100 version, also has built in HID Prox. Reader.
- ADA-compliant leversets. • Easy-to-install modified ANSI A115 Series door prep; easily and neatly retrofit standard cylindrical knobsets and mechanical standalone locks, in under an hour. Non-handed
- 3 hour UL fire-rated deadlatch.
- Supports 1-5/8 to 1-7/8" door thickness; 2-3/4" backset (2-3/8" available.)
- Manual key override standard; most IC cores also supported on interchangeable core models.

- Wide choice of 3 Architectural finishes (US3 polished brass, 26D satin chrome, 10B duronodic) and IC core preps (6-7pin).

#### Network Interface

**INTERFACE:** Ethernet 10Base-T or 100Base-TX (using RJ45 Jack)

**PROTOCOLS:** TCP/IP, UDP/IP, DHCP 802.11 Wireless Specifications

**WIRELESS STANDARDS:** IEEE 802.11b; 802.11g

**FREQUENCY RANGE:** 2.412 - 2.484 GHz

**OUTPUT POWER:** 14 dBm + 1.5 dBm/-1.0 dBm

**MAXIMUM RECEIVE LEVEL:** -10dBm (with PER < 8%)

**DATA RATES WITH AUTOMATIC FALLBACK:** 54Mbps - 1Mbps

**RANGE:** Up to 328 feet indoors

**MODULATION TECHNIQUES:** OFDM, DSSS, CCK, DQPSK, DBPSK, 64 QAM, 16 QAM

**INTERFACE:** Wireless 802.11b, 802.11g and 10/100 Ethernet

**PROTOCOLS:** TCP/IP, UDP/IP, DHCP

#### SECURITY

- IEEE 802.11 - PSK with AES Encryption 128-bit Encryption
- 128-bit AES Rijndael encryption

#### A.L. Radio Link

- 900 MHz GFSK, 50 channels, 10mW power output

**VOLTAGE:** 5 - 6 volts AC/DC

**OPERATING TEMPERATURE:** -20° to 60°C (-4° to 140°F)

**STORAGE:** -40° to 85°C (-40° to 185°F)

#### AVERAGE POWER CONSUMPTION:

- 1300 mW (WLAN mode; maximum data rate)
- 300 mW (WLAN mode; idle)
- 750 mW (Ethernet Mode)

**PEAK SUPPLY CURRENT:** 650 mA

**INPUT VOLTAGE:** 5 - 6 volts AC/DC

**OPERATING TEMPERATURE:** -31 to 151° degrees F

**STORAGE TEMPERATURE:** -40° to 85°C (-40° to 185°F)

No network activity or bandwidth usage until user operates DL Windows software to send programming to or receive log data from locks. Exception, during emergency lockdown command Gateways communicate through the network. Gateways will send less than 1000 bytes during emergency command.

# Trilogy Networkx: A wireless model for every application



## More Networkx Models & Options:

**PDL6100** Cylindrical Trilogy® Networkx™ PIN/Prox. Wireless Access Control Lock with built in HID proximity ID card reader, full-metal digital keypad, integral bi-directional radio, 4-C cell battery-operated (batts. supplied), serial number ID card, standard format SCI keyway for manual key override, 4-7/8" ASA Strike (includd).

**DL6100** Cylindrical Trilogy Networkx PIN-Code Wireless Access Control Lock, as above, with full-metal digital keypad only.

**PDL6500** Trilogy® Networkx™ PIN/Prox. Wireless Access Control Mortise Lock with built in HID proximity ID card reader, full-metal digital keypad, integral bi-directional radio, 4-C cell battery-operated (batts. supplied), serial number ID card, standard format SCI keyway for manual key override, 4-7/8" ASA Strike (includd).

**DL6500** Trilogy Networkx PIN-Code Wireless Access Control Mortise Lock, as above, with full-metal digital keypad only.

**PDL7100** Cylindrical Trilogy Networkx™ iClass™ Prox. Wireless Access Control Lock with built in 13.56 MHz iClass HID proximity ID card reader /enroller, full-metal digital keypad, integral bi-directional radio, 4-C cell battery-operated (batts. supplied), serial number ID card, standard format SCI keyway for manual key override, 4-7/8" ASA Strike (includd).

**PDL7500** Mortise version of above

**ETDLN TrilogyExit** Clutch Mechanism insures long life and durability. Fingertip and/or Windows programmable, 2000 User Codes: Master, manager, supervisor and users, Real Time Clock for up to 35,000 Event Time/Date-Stamped Audit Trail and Up to 500 Lock/Unlock Schedules (with Time Zone Support). Rugged 12-Button Metal Keypad, non-Handed; Fully Field Reversible. Adaptable to most major manufacturers of standard RIM and IC RIM Cylinder. Supports most panic exit devices, including Von Duprin, Corbin, Yale, Dorma, Arrow, Sargent, Precision and Cal Royal

**ETPDN Networkx Prox Trilogy Exit** model for added convenience and security. Includes all of the features above plus: Accepts most HID Proximity cards and keyfobs; Users are individually programmed to use a card only, code only, or for highest security – both card and code. Prox card data can be added to software by uploading from lock, by using AL-PRE or entering directly from computer using DL-WINDOWS Networkx software.

**RR-4BKEYFOB** Optional remote release keyfob (shown).

**RR-1BUTTON** Optional desk-mount version of above.

## DL-WINDOWS

Free Alarm Lock Trilogy Microsoft Windows-based software application, v4.0.1 or higher, supports Trilogy Networkx and Trilogy standalone locks, with single database. No-charge, downloadable online at [www.alarmlock.com](http://www.alarmlock.com)

## AL-IM80211

Hardware/Wireless Gateway Interface Module, with integral bi-directional radio, interfaces Networkx locks with PC network with hardwired Ethernet and wireless 802.11. Powered with Class 2, 6VAC transformer (supplied). Supports up to 63 Networkx Locks. Two antennas. Ceiling or wall mountable.

**AL-IME** Hardware Gateway Interface Module, supports up to 63 Networkx Locks, similar to above, but using hardwired connection to the network via RJ45 Ethernet cable. One antenna. Powered with Class 2, 6VAC transformer (supplied). Ceiling or wall mountable.

**AL-IMEPOEP** Hardware Gateway Interface Module + POE, supports up to 63 Networkx Locks, as above, but using hardwired Ethernet and Power Over Ethernet (P.O.E.). Connects directly to a network via Ethernet cable. One antenna. Ceiling or wall mountable.



Add Networkx Trilogy convenience, programming, flexibility, audit trail and wireless connectivity to panic exit devices from most major manufacturers

Turn Standalone Trilogy Locks into Wireless Networkx Locks with New Field Upgrade Kits for Standalone PIN or PIN/Prox Cylindrical or Mortise Models. Call for more or go to <http://www.alarmlock.com/networkupgradekits.html>



# Wireless Network Keypads & NetPanel



Trilogy Network Wireless Keypads and NetPanel combine to provide the ideal wireless keypad solution for use with mag locks, strikes and electrified exit devices in a smart access system with advanced features & functions, like automatic schedules, event logs and support for 2000 doors and 5000 existing Prox. ID Cards/Badges. The Network Panel communicates via a Network Gateway networked to any Windows-based PC. Networkx keypads seamlessly share one common database hosted on free Alarm Lock free software (along with Networkx locks and standalone Trilogys too.). This cost effective system is very scalable, and up to 63 NetPanels, controlling up to 126 Network Keypads (or wiegand devices), can communicate to as little as one Alarm Lock Gateway. Two starter kits are available, NET-DKPAK & NET-PDKPAK, each with a controller and keypad (Digital PIN or Prox, respectively). Additional keypads and NetPanels may also be purchased individually.

## Advantages

- New Wireless Keypad solution - networked versions of popular Trilogy DK/ PDK3000 Keypads
- Ideal for use with strikes, mags, electrified exit devices
- 5000 users with 3-6 digit PINs or HID® ID cards
- Save manpower - Bidirectional 802.11/ ethernet network communications updates, users, time-schedules and audit trail queries — without ever going to the keypads

## NET-DKPAK & NET-PDKPAK

**Versatile for indoors and outside; ideal for education, healthcare, government, airports, courts, municipalities, & retail**

- Familiar Trilogy operation, programming, software and ruggedness
- NetPanel Controller supports 2 Network keypads and/or 2 Wiegand output readers /devices
- Key features: Global lockdown and passage from keypad or PC, schedules, 35K event log, door position status indicator, request-to-exit, door ajar/kick-in, remote release options.

## Features

- Networkx NetPanel supports up to 2 Network wireless keypads and/ or Wiegand-output readers and communicates wirelessly via Ethernet or 802.11B/G for a comprehensive wireless networked door access control system, eliminating door-to-door programming and audit trail retrieval and providing all standalone Trilogy lock functionality plus new network-wide global emergency lockdown/unlock commands
- Networkx Keypads support up to 5000 users with 3-6 digit numeric PIN codes and NETPDK-Series also support prox ID card users (virtually all HID format proximity technology ID cards, fobs, credentials.)
- System-wide free-passage enable or disable, can be activated from the keypad or the Networkx PC
- On demand, in seconds, wirelessly change keypad users, schedules, features or retrieve 35,000 events from any networked PC.
- Ideal for use with mag locks, strikes and electrified exit /panic devices (EL-devices/ electrified latch retraction devices.)

- Free Alarm Lock DL-WINDOWS software doesn't require a dedicated computer or a special computer network or costly server software licenses, it simply runs as a secure Microsoft Windows-based application, on any computer system (as basic as a desktop or laptop PC), a wired or wireless router, and a gateway module or on an internal LAN with static IP address (recommended). MS XP and Vista supported (v4.01 or higher).
- Wall- or ceiling-mountable, compact Alarm Lock Networkx Gateway Modules and are available in wireless/hardwired and wired-only versions (with Power Over Ethernet (POE) option). The hybrid model connects using either 802.11 or standard Ethernet cable; the wired versions use an RJ-45 Ethernet cable. Networkx communications support both wired Ethernet 10BaseT and wireless 802.11. Networkx Gateways' wireless coverage performance equals or surpasses that of 802.11, with each Gateway spanning up to 900' clear field range or 50,000 square feet of indoor coverage, typical\*\*\*.
- Up to 50 wall- or ceiling-mountable, compact gateway modules can be used per account and are available in wireless/ hardwired and wired-only versions, (with Power Over Ethernet (POE) option). The hybrid model connects using either 802.11 or standard Ethernet cable; the wired versions use an RJ-45 Ethernet cable. Networkx communications support both wired Ethernet 10BaseT and wireless 802.11.
- Up to 2000 NetPanels can be used per account to further expand system capabilities.

# NETPANEL dedicated access panel Includes

- Circuit board with onboard flash memory; 12V power supply, with transformer and rechargeable backup battery
- Inputs supporting two of any combination of NETDK or NETPDK keypads, PLUS up to two Wiegand devices
- Special "Two Door Mode" allows two keypads and/or two Wiegand devices to separately control two doors
- Two Form-C relays
- Inputs for door position contact to indicate the status of the door, open or closed;
- Inputs for a remote release button or sensor
- Onboard bi-directional Networkx radio
- Wiegand interface, red LED, green LED, and sounder.

## Wiegand Device Support

- The NetPanel's Wiegand inputs currently support all Wiegand output devices, that support the Data 0/Data 1 communications protocol and are compatible with HID Prox credentials (including Wiegand keypads and combination units.)

## Examples of Wiegand Devices Supported:

- HID Classic Swipe Wiegand Reader Model 310 (36-bit card format compatible).
- HID ProxPro with Keypad Model 5355
- HES model RF5910 Hybrid Electric Strike with HID125k reader

\*\*\* Other formats may be accommodated for special orders. Ask you Alarm Lock Representative.

## Ordering Info.

**NETPDKPAK26D** Complete 2-Door NetPanel System with 1 PDK wireless keypad with built in HID Prox Reader, 26D finish. \*\*\*\* Includes 12 volt power supply, onboard bidirectional radio, 4Ah/12V rechargeable backup battery and plug in AC transformer. (System requires use of one of the AL-IM Series Gateway Modules, separately purchased.)

**NETDKPAK26D** Complete 2-Door NetPanel System with 1 DK wireless keypad, 26D finish. \*\*\*\* Includes 12 volt power supply, onboard bidirectional radio, 4Ah/12V rechargeable backup battery and plug in AC transformer. (System requires use of one of the AL-IM Series Gateway Modules, separately purchased.)

**NETPDK26D** PDK Wireless Keypad with built in HID Prox Reader only, 26D finish. \*\*\*\*

**NETDK26D** DK Wireless keypad only, 26D finish.

\*\*\*\*Note: Special keypad finishes may also be available – ask your Alarm Lock Rep.)

**NETPANEL** Access Control Panel to be used with other approved Wiegand output readers. Includes 12 volt power supply, onboard bidirectional radio, 4Ah/12V rechargeable backup battery and plug in AC transformer.

**DL-WINDOWS** Free Alarm Lock Trilogi Microsoft Windows-based software application, v.4.177 or higher, supports Trilogi Network Wireless Keypads, Locks and Trilogi stand-alone locks, with single database. No-charge, downloadable online at [www.alarmlock.com](http://www.alarmlock.com)

**AL-IM80211** Hardware/Wireless Gateway Interface Module, with integral bi-directional radio, interfaces Networkx keypads/locks with PC network with hardwired Ethernet and wireless 802.11. Powered with Class 2, 6VAC transformer (supplied). Supports up to 63 Networkx NetPanels. Two antennas. Ceiling or wall mountable.

**AL-IME** Hardware Gateway Interface Module, supports up to 63 Networkx NetPanels, similar to above, but using hardwired connection to the network via RJ45 Ethernet cable. One antenna. Powered with Class 2, 6VAC transformer (supplied). Ceiling or wall mountable.

**AL-IMEPOEP** Hardware Gateway Interface Module + POE, supports up to 63 Networkx NetPanels, as above, but using hardwired Ethernet and Power Over Ethernet (P.O.E.). Connects directly to a network via Ethernet cable. One antenna. Ceiling or wall mountable.

\*\* Note: Battery life is directly proportionate to activations: users, door usage, program updates and audit trail downloads. Expected 5 year+ battery consumption estimate assumes 2000 authorized users, 100 passes per day, 365 days per year; daily updates changing one user and downloading 200 logged events every day.

\*\*\* Note: Actual coverage is dependent upon building construction and mounting location of Gateway. Multiple AL-IM Series Gateways may be used for large coverage areas.

## SIMPLE NETWORKX WIRELESS KEYPAD SYSTEM

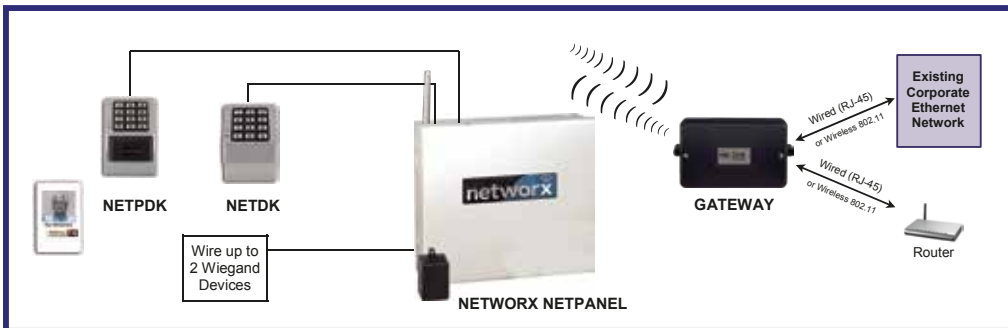

## MAGNETIC LOCK AND/OR ELECTRIC DOOR STRIKE ONE OR TWO DOORS/ TWO KEYPADS AND/OR TWO WIEGAND DEVICES

The system is capable of controlling two doors using up to two of any combination of NETDK or NETPDK keypads, PLUS up to two Wiegand devices. Two auxiliary Form-C relays are available for up to two of any combination of magnetic locks and/or electric door strikes.

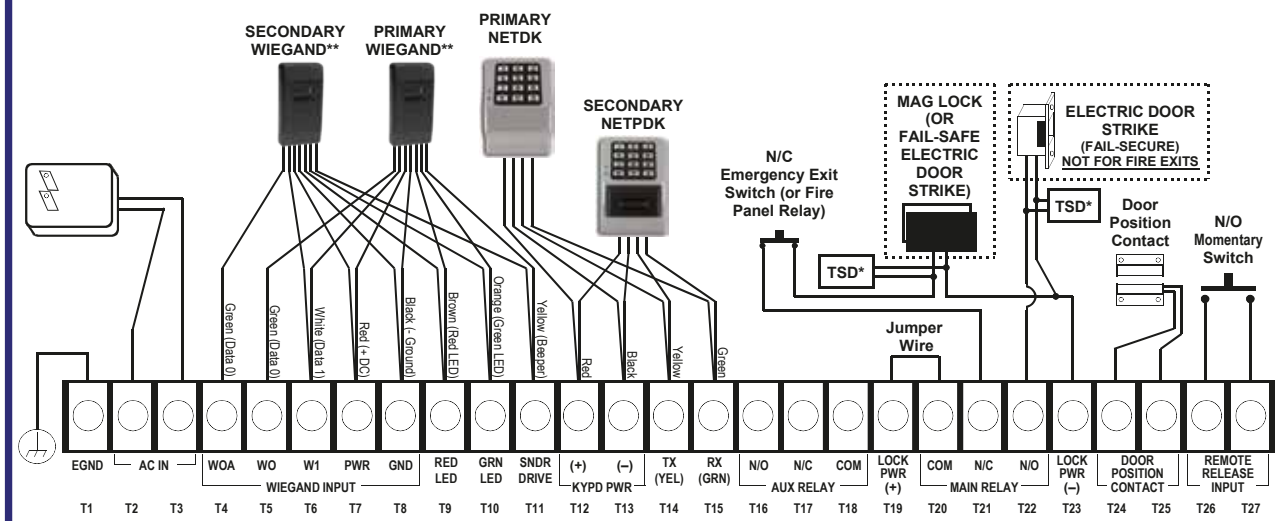

\*TSD = Transient Suppression Device (two supplied): Mount the TSD as close to the device to be protected as possible.

\*\*Example device shown: HID ProxPoint® Plus Model 6005B.

# ArchiTech: Designer Wireless Access Control Platform



**ArchiTech Series Networkx Locks are an ideal access control solution; elegantly blending advanced wireless access control convenience within any décor, in an attractive, infinitely customizable designer locking form factor, in choice of trims and finishes.** Ideal for educational, commercial office or multi-dwelling residential settings, these stylish, durable locks, leveraging proven Networkx access control technology, offer a choice of ID credential technology, and can be used to control access a door at a time; across a wireless network; or as an integral part of a new or existing enterprise security system—spanning a few, or thousands of doors, in one building, a campus or multiple sites around the world.



*Cylindrical; Surface Mounted Electronics (back box not shown)*



*Mortise; Surface Mounted Electronics*

## Performance Overview

- **All Applications and Doors** - Cylindrical and Mortise models for wood and metal doors, for new and existing applications, with wireless surface mount or mortised-in electronics and batteries.
- **Customize To Match Any Aesthetic Look, For Every Décor** - Over 300 locks, levers, roses and finishes to choose from, durable ANSI/BHMA Grade 1 hardware over 300 locks, levers, roses and finishes
- **Future-Proof Multi-Technology Access ID Credentials Replace Cumbersome Keys** – HID® Prox, Mag Stripe, Smart Cards, PIV, keyfobs and remote buttons
- **Emergency Lock-Down** option via lock, button, keyfob or server (where networked). (Global Un-lock via server too.)
- **Proven, Low Maintenance, Wireless Installation And Unsurpassed Battery-Life with Advanced Power-Saver circuit**, with years of use in even high-traffic areas, using off-the-shelf AA batteries.
- **Flexible System Programming** Locally using a USB Gateway or remotely across a wireless network (using free Alarm Lock DL-WINDOWS Windows- based software) or integrated on an enterprise class IT environment, in realtime, using LENEL
- **Networking Choices** – Choose 802.11 or Ethernet network, with wireless encrypted bi-directional gateways, in which many locks communicate to a single gateway, or use a wireless RF USB Gateway equivalent. For entry door applications and the like, used in conjunction with strikes and mags, use with Networkx NetPanels. Or, use as a single-door control, in real time, as part of the IT-Network environment, with Continental Access CA3000 or Lenel OnGuard® Integrated Access Control & Video Security Platforms.



CardAccess 3000

## Standard Configurations

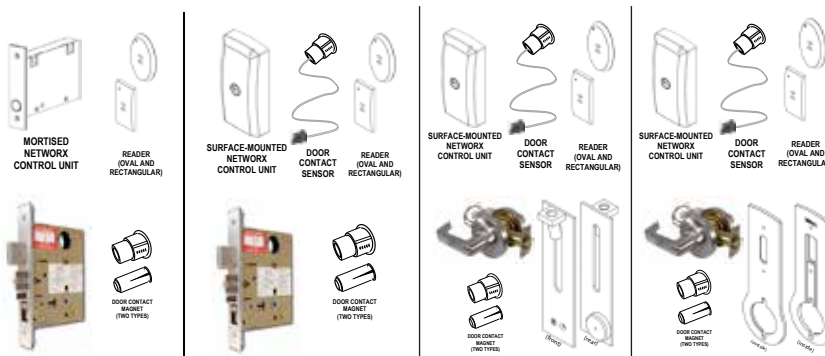



# ArchiTech: Standalone or Networked Access



## Standalone Specifications

- **ArchiTech Series combine attractive, durable Grade 1 locksets with proven wireless Networkx access control technology** in one aesthetically - pleasing standalone access control and locking package.
- **Ideal for all discriminating applications**, from high-rise residences or offices to universities, anywhere keyless access control would be welcome and convenient
- **Support for a variety of access control credentials** from ID cards and badges, e.g., prox., mag stripe and smart cards, to several keyfob styles.
- **Ultra décor-compatible, there are unlimited combinations of 300+ architectural trims, lever or knob designs trims & finishes**, for an entirely custom look – all durable ANSI/BHMA Grade 1.
- **Flexible for any application and door, wood or metal**, the standalone, self-contained system is wireless and can be surface mounted or recessed within the door
- **Low maintenance**, the durable system is also powered by 4 off-the-shelf AA Batteries – with unsurpassed long-battery life for up to 3 to 4 years using advanced Power-Saver circuit.
- **Readily networked for future requirements**



*Shown with mortised-in electronics and batteries*

## **Features:**

- 5000 Users, 500 Scheduled Events & 40,000 Event Audit Trail
- Surface-Mount or Mortised-in Electronics and Battery Pack
- Lock available in Mortise and Cylindrical versions
- Real Time Clock
- Uses 4 AA Batteries – 3 to 4 year battery life, typ. using advanced Power-Saver circuit.
- Operated via access card, key fob etc.
- DL-Windows Software for programming
- USB Radio Gateway Method or Via Networkx Gateways (Ethernet, 802.11 or POE)
- Manual Card Enrollment Option for Quick Installation
- Wireless programming range: up to 100 ft.
- ANSI / BHMA Grade 1 Certified, UL Listed 3 Hours
- Auto-Deadbolt option for automatic keyless locking of deadbolt upon exiting, ideal for residential applications
- Includes standard lever rose hardware design
- Compatible with all 300+ optional architectural trim / lever or knob designs
- Stainless steel latch, 2-3/4" backset
- Auto-Reverse lock body tested to 6 million cycles
- Lock Body - Self cleaning long life motor
- Door closure monitor / electronic deadbolt monitor
- Key override standard or high-security
- Optional integrated door position indicator switch

# ArchiTech: How To Order & Trim Options



Standard Model Ordering. Infinite Custom Models Also Available, Call for Ordering Assistance

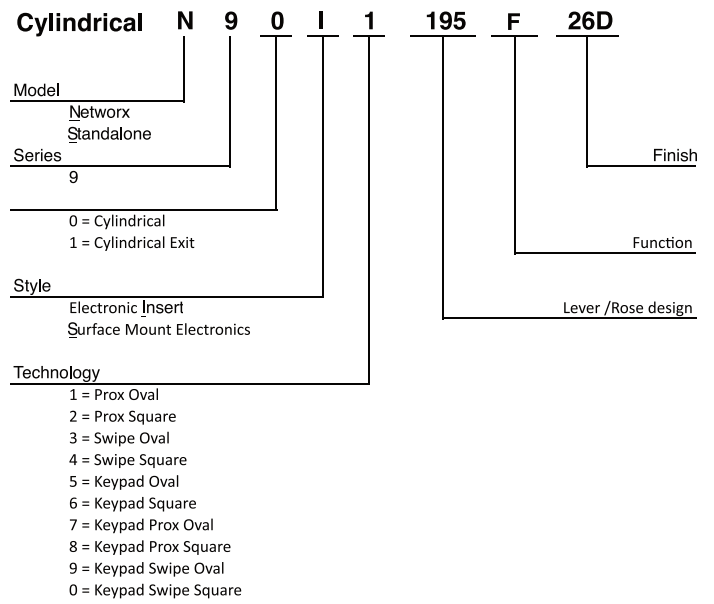
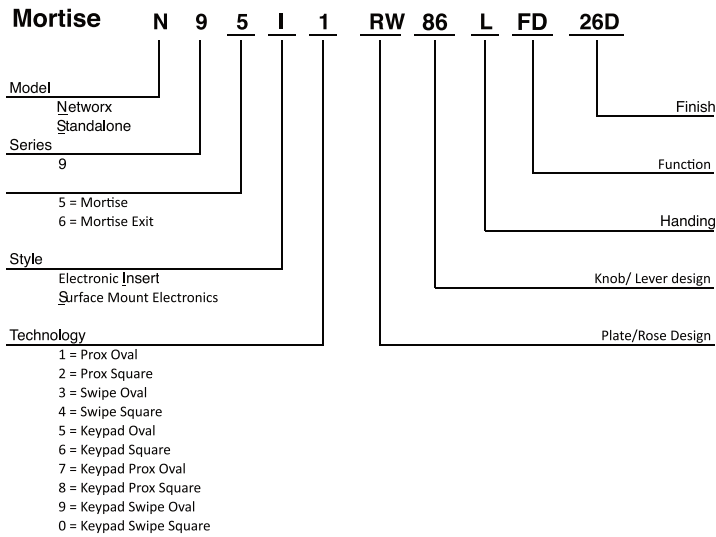

## Trim Options for Cylindrical ArchiTech Series



195  
American

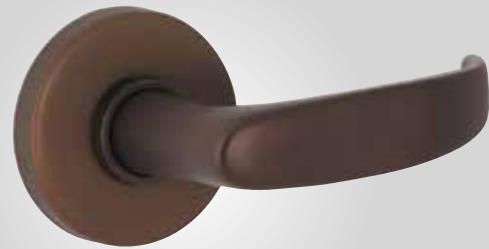

295  
Crescent



395  
Monaco



495  
Titan

Note: Cylindrical versions use the round roseplate.

# Trim Options for Mortise ArchiTech Series

## ROSE STYLE:

---



Rose RR



Rose RW



Rose RS



Rose RQ



Rose RX

## LEVER STYLE:

---



Ball 20\30



Monaco 57

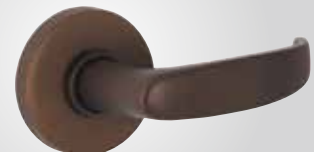

Crescent 86



American 92



Titan 96

Note: Please consult factory for other lever styles, finishes and lead times.

## New Networx Accessories



### AL-IME-USB

Portable Gateway that provides full Networx Gateway functionality without the need for a network connection.



### AL-NSG

A portable battery powered Gateway simulation device that generates continuous Gateway radio signals to a Networx Signal Meter.



### AL-NSM

Performs a site survey test of the premises to find optimum location of Networx gateways and locks. It is also used to determine the number of gateways required to cover the signal area of the Networx locks you plan to install.



# Sirenlock: Panic exit alarms

Sirenlock™ Models 250, 260, 700, and 710 are UL Listed panic alarm deadbolt devices which restrict unauthorized use of exit doors by sounding an alarm, while providing instant egress in emergencies



## Delayed egress exit alarm

### SIRENLOCK™ MODEL 715

- Offers stylish, cost-effective control of unauthorized use of exit doors
- 15 second delayed egress with instant 95db Dual Piezo alarm (meets UL specifications)
- Instant alarmed exit in case of actual emergency or fire (meets NFPA 1012 Life Safety Code)
- Easy-to-install, surface mount unit in a standard panic bar deadbolt/deadlatch design
- Monitoring output for simultaneous use of CCTV camera, secondary siren, remote monitoring console, etc.
- Smoke detector input can be used to power existing system or standalone smoke detector(s) (Includes armored door cord and cables for wiring)
- 9V battery back-up powers in event of power failure
- Requires standard RIM cylinder (not included)

### MODEL 11A (Not Shown)

(Dead bolt only; Not for ADA applications)

- Model 11A is an exit lock designed to control unauthorized use of emergency doors. It provides trouble free service and deters theft from within and outside. Unauthorized use sounds alarm which can only be reset or bypassed with key. Standard features include 1 inch throw deadbolt, warning alarm, outside cylinder capability, tamper switch and long life battery pack. Available for use with double doors or for use with existing panic bars. Optional AC power supply. Requires standard RIM cylinder (not included).

## Clapper plate & full door exit style alarms

### A – SIRENLOCK™ MODEL 250/260

### B – SIRENLOCK™ MODEL 700/710

- Deadbolt and deadlatch meet relatching requirements
- Blaring 95db dual tone siren
- Selectable 2-minute alarm or constant alarm
- 9V battery powered and audible low battery warning
- Meets or exceeds UL, CFM, ADA, NYC housing requirements
- 250/700 Models have changeable 2 minute alarm cutoff or manual reset.
- 260/710 Models have changeable 2 minute auto reset or manual reset
- Models 700 and 710 are available in 33" and 48" versions
- Model 700 is also available in red finish (700XRD) and 312 (Duronotic)
- Non-handed surface installations on single or double doors
- Requires standard RIM cylinder (not included)

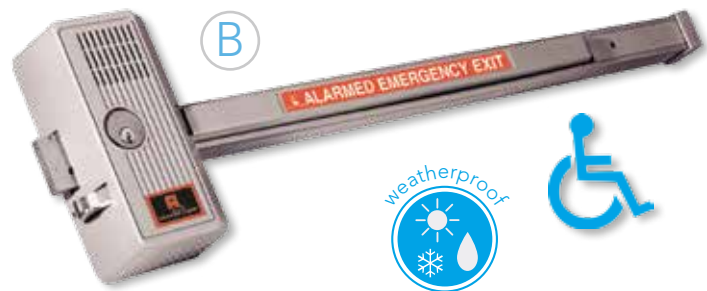

## Waterproof electronic alarmed panic locks

### 700/710x28WP and 250/260x28WP (models same as above)

- Suitable for outdoor use
- Weather-resistant for exposure to rain and precipitation, even in harsh conditions
- Wide operating temperature of -20°F to +140°F (-29° to +60°C)
- Powered with long-life sealed 9VDC alkaline battery pack (BP9)
- Loud 99db alarm

# Mags: Remote release mags, powermags & RTEs

## Innovative remote release mag-kit

### KIT RR-PM1200PAK

- Advanced 1200 lb. Electromagnetic Lock with Infrared Remote Release
- The power of a mag with the convenience of pocket-size remote controls for reception or staffers
- Complete turnkey system includes: Advanced 1200 lb. Mag, one remote control, and plug-in AC transformer
- Plug-in 12VAC transformer eliminates the requirement for pulling wires or the services of an electrician (optional use)
- Supports up to 100 individual remote controls (AL-REMOTE)
- Releases mag from either side of door
- AL-REMOTE Keyfob features single button operation with positive "click" response
- Automatically-enrolled by system in easy programming mode and is audibly and visually confirmed
- UL-listed; CE-listed



Easy buzz-in convenience from a mag lock. Ideal for reception areas!



## Electromagnetic locks

### PowerMag™ 12/24V

- Strong holding force of 600 and 1200 lb. models
- Perfect for both single and double doors and even sliding doors
- 5-year limited warranty
- Low voltage (12 or 24VDC); including field-selectable models
- Double door models with 1200 lb. locking per side (PM1200SLB1 and 40)

### PowerExit™ Request-to-Exit Push Buttons

- Come in five models, with or without illuminated buttons
- All models have solid aluminum anodized finish US28
- Sizes: 3' x 4 3/4" x 1/4" and 1 5/8" x 4 3/4" x 1/4"
- Back Depth: 1 1/4" and 1 7/8"
- Switch Rating: 250V AC 5A
- Momentary Action



## Electric door locks

### Models 103 & 104RA

- Models 103 & 104RA are compact electric locks simple to install on all types of doors. The door is locked or unlocked by remote switch, key switch, time programmer or other electrical contact which interrupts the power. Model 103 is our standard fail-safe unit which projects the bolt only while power is on. When the power is off the bolt retracts. Model 104RA (reverse action) unlike our standard unit is "fail-secure" and will project the bolt only when the power is "off." When the power is on the bolt retracts. 24AC/DC and 12VAC/DC models available



# Door alarms: Advanced and multi-purpose

The PG21MS Series includes advanced narrow-stile microprocessor-controlled door alarms for surface mounting on a door or door frame. Typical applications include emergency fire escape doors, nursing home stairwell doors, rear restaurant and theater doors.

## Models PG21MS/PG21MB

- Two selectable arming modes –
  1. **Always armed mode** – when key is turned counter clockwise to the disarm position, the key cannot be removed. To remove key, turn back to arm mode, thus keeping unit armed always.
  2. **Standard arming mode** – when key is inserted turning counter clockwise will disarm and key can be removed. Turning key clockwise will arm and key can be removed.
- Max-Flex Terminals, allowing for any or all of the following:
- Continuous power with the addition of an external power supply
- Multiple door monitoring permitted with built-in external reed switches
- Status Indicator – The LED will indicate RED when armed.
- Entry Delay Time Options – include 15 seconds, 1 minute 15 seconds & 3 minutes 15 seconds
- Sleek model design key-activated door alarm for use on standard size and narrow stile doors
- Unauthorized use of door causes alarm to sound and activates LED indicator
- Options include continuous alarm, minute shutdown with auto reset and exit/entry delay
- Uses standard mortise cylinder (not included)
- Tamper switch supervised
- For exterior key control, optional RIM cylinder may be used
- Metallic silver or duronodic finish
- Relay option
- Optional Strobe unit (shown) – PG21MSS/PG21MBS units include a highly visible amber strobe will flash when unit goes into alarm



## Model PG30KPD:

Keypad-controlled narrow stile door alarm, similar to PG21, plus:

- Digital codes for master, management and passage (used for auto-arming)
- 3 security levels for: a) high security b) unattended applications c) flexible control for delivery doors, etc.
- Audible low battery warning
- 3 Programmable 95db siren styles: sweep, pulsed, and steady
- Logo key is dual function test button



## PG30KPD Accessory:

- For optional use with the PG30, this low-profile, brushed aluminum finished accessory provides all functions of the PG30 from the outside of the door. (Available in metallic silver only.)

## Model PG10

- The Pilfergard Model PG10 is an exit door alarm designed to deter the use of the secured door by sounding a twin action alarm when opened by unauthorized personnel. The alarm can be bypassed from inside or outside by the use of a key. (Requires standard mortise cylinder not supplied.) This durable surface mount unit is easily installed and is tamper-supervised with two separate tamper switches. Its test button verifies battery. Optional AC power supply available.

## Model LL1

- All of the features of the PG10 unit with addition of a flashing strobe for easy alarm identification.
- Choice of system controllers





# Alarm Lock: Essential add-ons and extras

## Strikes for model 11A:

### Model 210K

- Strike for single or double inswinging door(s) (not included with 11A)

### Model K24A

- Strike for single outswinging door (included with 11A)

### Model K28

- Strike for double outswinging doors (not included with 11A)



## Rim cylinder

### Model CER

- Required for interior arming/disarming of models 11A, 80, 250, 260, 700, 710 & 715. Includes two keys (KA or KD)



## Mortise cylinder

### Model CEM

- Used with the Pilfergard models PG10 and PG21/E to arm and disarm the alarm circuit. Includes two keys (KA or KD)



## Cylinder finger pull

### Model 711

- An inexpensive door pull for use when outside key only access is required.



## Outside access door pull

### Model 707

- For access from building exteriors. Installed on the outside of the door and linked to the lock. After deadbolt is retracted by outside key, a slight pull will release the deadlatch and open the door. 8" x 1 1/2". (For use with all models except Model 11A).



## Battery eliminator

### Model PP100

- For use with all PG10, PG21/E, PG30, 250, 700, 80, 260, 710 and 715 models. The PP100 conserves the battery which automatically takes over as the power source to sound the alarm in the event of a power failure or intentional cut-off. A built-in circuit breaker with push-button reset eliminates troublesome fuse replacements. Includes a cam lock cylinder and 6' of armored cable adequate to provide a door loop at the hinged-side of the door. Can be used with all 6V and 9V models.



## Double door holder

### Model 44

- The Double Door Holder secures the inactive door to the frame while the active door is closed. Releasing the active door automatically allows both doors to swing freely. Reversible, right or left hand doors. Cast aluminum 8 1/2" long, 3" wide and 2 1/2" high.



## Armored door loop

### Model 271

- For use with electrified locks. An easy means for bringing electric current from the hinge side of a door frame to the door. 18" flexible armored cable. End brackets are deep drawn anodized aluminum to conceal wire connections.



## Single door strike

### Models 730 & 725

- Model 730 supplied with models 250, 700 and 80
- Model 730M supplied with models 260 and 710 and 80
- Model 725 supplied with model 715



## Double door strike

### Models 732 & 735

- Model 732 for use with models 250, 700 and 80.
- Model 732M for use with models 260 and 710.
- Model 735 for use with model 715. (Not Shown)



## Cable energy switch

### Model 261

- Transfers current to other side of the door.
- For use with models 250, 100 and 11A

# Trilogy & Networx: Standalone and Wireless Access

| MODEL/<br>FEATURE           | DL2700  | DL2800  | DL3000  | PDL3000   | DL3200  | DL3500                              | PDL3500                             | DL4100  | PDL4100   | DL4500   | PDL4500  | DL5200   | DL5300   | PDL5300  | DL6100  | PDL6100   |
|-----------------------------|---|---|---|---|---|-------------------------------------|-------------------------------------|---|---|--|--|--|--|--|---|---|
| Lock Type                   | Cylindrical   | Cylindrical   | Cylindrical   | Cylindrical Prox  | Cylindrical   | Mortise                             | Mortise Prox                        | Cylindrical   | Cylindrical Prox  | Mortise  | Mortise Prox   | Cylindrical  | Cylindrical  | Cylindrical Prox   | Cylindrical 802.11 Ethernet   | Cylindrical Prox 802.11 Ethernet  |
| User Codes                  | 100   | 200   | 300   | 2000  | 2000  | 300                                 | 2000                                | 2000  | 2000  | 2000   | 2000   | 100  | 2000   | 2000   | 5,000   | 5,000   |
| Code Length                 | 3-6 digits  | 3-6 digits  | 3-6 digits  | 3-6 digits  | 3-6 digits  | 3-6 digits                          | 3-6 digits                          | 3-6 digits  | 3-6 digits  | 3-6 digits   | 3-6 digits   | 3-6 digits   | 3-6 digits   | 3-6 digits   | 3-6 digits  | 3-6 digits  |
| Programming                 | Keypad only   | Keypad /PC  | Keypad /PC  | Keypad /PC  | Keypad /PC  | Keypad /PC                          | Keypad /PC                          | Keypad /PC  | Keypad /PC  | Keypad /PC   | Keypad /PC   | Keypad only  | Keypad /PC   | Keypad /PC   | Keypad /PC  | Keypad /PC  |
| Vandal-Proof Keypad         | All metal, 12 button  | All metal, 12 button  | All metal, 12 button  | All metal, 12 button  | All metal, 12 button  | All metal, 12 button                | All metal, 12 button                | All metal, 12 button  | All metal, 12 button  | All metal, 12 button   | All metal, 12 button   | Dual sides, All metal, 12 button   | Dual sides, All metal, 12 button   | Dual sides, All metal, 12 button   | All metal, 12 button  | All metal, 12 button  |
| Trim w/Rugged Clutch        | Straight or curved lever  | Straight or curved lever  | Straight or curved lever  | Straight or curved lever  | Straight or curved lever  | Straight or curved lever            | Straight or curved lever            | Straight or curved lever  | Straight or curved lever  | Straight or curved lever   | Straight or curved lever   | Straight or curved lever   | Straight or curved lever   | Straight or curved lever   | Straight or curved lever  | Straight or curved lever  |
| Audit Trail Events          |   | 1000  | 1600  | 40000   | 40000   | 40000                               | 40000                               | 40000   | 40000   | 40000  | 40000  |  | 40000  | 40000  | 35,000  | 35,000  |
| Scheduled events            |   | 150   | 150   | 500   | 500   | 500                                 | 500                                 | 500   | 500   | 500  | 500  |  | 500  | 500  | 500   | 500   |
| Proximity Reader            |   |   |   | Prox HID  |   |                                     | Prox HID                            |   | Prox HID  |  | Prox HID   |  |  | Prox HID   |   | Prox HID  |
| Privacy Lockout             |   |   |   |   |   |                                     |                                     | Privacy/ Lock-out   | Privacy/ Lock-out   | Privacy/ Lock-out  | Privacy/ Lock-out  |  |  |  | Global lockdown   | Global lockdown   |
| Classroom/ Deadbolt         |   |   |   |   |   | CR or DB                            | CR or DB                            |   |   | DB   | DB   |  |  |  |   |   |
| Weather-proof -31 to 151° F | WP version  | Standard  | WP version  | Standard  | Standard  | Standard                            | Standard                            | Standard  | Standard  | Standard   | Standard   | Standard   | Standard   | Standard   | Standard  | Standard  |
| Handing                     | Nonhanded   | Nonhanded   | Nonhanded   | Nonhanded   | Nonhanded   | Handed; Field Reversible            | Handed; Field Reversible            | Nonhanded   | Nonhanded   | Handed;  | Handed;  | Nonhanded  | Nonhanded  | Nonhanded  | Nonhanded   | Nonhanded   |
| Door Thickness              | 1-5/8 to 1-7/8" (others on request.)                                      | 1-5/8 to 1-7/8" (others on request.)                                      | 1-5/8 to 1-7/8" (others on request.)                                      | 1-5/8 to 1-7/8" (others on request.)                                      | 1-5/8 to 1-7/8" (others on request.)                                      | 1-5/8 to 1-7/8"                     | 1-5/8 to 1-7/8"                     | 1-5/8 to 1-7/8" (others on request.)                                      | 1-5/8 to 1-7/8" (others on request.)                                      | 1-5/8 to 1-7/8"  | 1-5/8 to 1-7/8"  | 1-5/8 to 1-7/8" (others on request.)   | 1-5/8 to 1-7/8" (others on request.)   | 1-5/8 to 1-7/8" (others on request.)   | 1-5/8 to 1-7/8" others upon request                                       | 1-5/8 to 1-7/8" others upon request                                       |
| Backset                     | 2-3/4" (included); 2-3/8" option.   | 2-3/4" (included); 2-3/8" option.   | 2-3/4" (included); 2-3/8" option.   | 2-3/4" (included); 2-3/8" option.   | 2-3/4" (included); 2-3/8" option.   | 2-3/4" (included)                   | 2-3/4" (included)                   | 2-3/4" (included); 2-3/8" option.   | 2-3/4" (included); 2-3/8" option.   | 2-3/4" (included)  | 2-3/4" (included)  | 2-3/4" (included); 2-3/8" option.  | 2-3/4" (included); 2-3/8" option.  | 2-3/4" (included); 2-3/8" option.  | 2-3/4" (included); 2-3/8" opt.  | 2-3/4" (included); 2-3/8" opt.  |
| Cylinder                    | Large key-in-knob, incld -or- IC Prep for Best/Falcon/ Arrow (w/o cyl.d.) | Large key-in-knob, incld -or- IC Prep for Best/Falcon/ Arrow (w/o cyl.d.) | Large key-in-knob, incld -or- IC Prep for Best/Falcon/ Arrow (w/o cyl.d.) | Large key-in-knob, incld -or- IC Prep for Best/Falcon/ Arrow (w/o cyl.d.) | Large key-in-knob, incld -or- IC Prep for Best/Falcon/ Arrow (w/o cyl.d.) | Generic mortise cylinder, supplied. | Generic mortise cylinder, supplied. | Large key-in-knob, incld -or- IC Prep for Best/Falcon/ Arrow (w/o cyl.d.) | Large key-in-knob, incld -or- IC Prep for Best/Falcon/ Arrow (w/o cyl.d.) | Generic mortise cylinder, supplied. Other cams available for cylinders | Generic mortise cylinder, supplied. Other cams available for cylinders | Large key-in-knob, incld -or- IC Prep for Best/Falcon/ Arrow (w/o cyl.d.). One cyl.d. needed for each side of door | Large key-in-knob, incld -or- IC Prep for Best/Falcon/ Arrow (w/o cyl.d.). One cyl.d. needed for each side of door | Large key-in-knob, incld -or- IC Prep for Best/Falcon/ Arrow (w/o cyl.d.). One cyl.d. needed for each side of door | Large key-in-knob, incld -or- IC Prep for Best/Falcon/ Arrow (w/o cyl.d.) | Large key-in-knob, incld -or- IC Prep for Best/Falcon/ Arrow (w/o cyl.d.) |
| Special Order Cylinders     | Yale, Medeco, Sargent, Corbin/ Russwin, Schlage                           | Yale, Medeco, Sargent, Corbin/ Russwin, Schlage                           | Yale, Medeco, Sargent, Corbin/ Russwin, Schlage                           | Yale, Medeco, Sargent, Corbin/ Russwin, Schlage                           | Yale, Medeco, Sargent, Corbin/ Russwin, Schlage                           |                                     |                                     | Yale, Medeco, Sargent, Corbin/ Russwin, Schlage                           | Yale, Medeco, Sargent, Corbin/ Russwin, Schlage                           |  |  | Yale, Medeco, Sargent, Corbin/ Russwin, Schlage  | Yale, Medeco, Sargent, Corbin/ Russwin, Schlage  | Yale, Medeco, Sargent, Corbin/ Russwin, Schlage  | Yale, Medeco, Sargent, Corbin/ Russwin, Schlage                           | Yale, Medeco, Sargent, Corbin/ Russwin, Schlage                           |
| Relay options               | yes   |   | yes   | yes   | yes   | yes                                 | yes                                 | yes   | yes   | yes  | yes  | no   | no   | no   | yes   | yes   |
| Battery/ Cycles Typical     | 5AA; 200000   | 5AA; 100000   | 5AA; 100000   | 5AA; 60000  | 5AA; 100000   | 5AA; 100000                         | 5AA; 60000                          | 5AA; 100000   | 5AA; 60000  | 5AA; 60000   | 5AA; 60000   | 5AA; 80,000  | 5AA; 100000  | 5AA; 60000   | 4 C cells 5 years 500,000   | 4 C cells 5 years 500,000   |
| Ratings                     | BHMA Grade 1 Lockset; 3hr. Fire Rated UL                                  | BHMA Grade 1 Lockset; 3hr. Fire Rated UL                                  | BHMA Grade 1 Lockset; 3hr. Fire Rated UL                                  | BHMA Grade 1 Lockset; 3hr. Fire Rated UL                                  | BHMA Grade 1 Lockset; 3hr. Fire Rated UL                                  | 3 Hr Fire Rated UL                  | 3 Hr Fire Rated UL                  | BHMA Grade 1 Lockset; 3hr. Fire Rated UL                                  | BHMA Grade 1 Lockset; 3hr. Fire Rated UL                                  | 3 Hr Fire Rated UL   | 3 Hr Fire Rated UL   | BHMA Grade 1 Lockset; 3hr. Fire Rated UL   | BHMA Grade 1 Lockset; 3hr. Fire Rated UL   | BHMA Grade 1 Lockset; 3hr. Fire Rated UL   | BHMA Grade 1 Lockset; 3hr. Fire Rated UL                                  | BHMA Grade 1 Lockset; 3hr. Fire Rated UL                                  |
| Architectural Finishes      | US26D, US3, 10B   | US26D, US3, 10B   | US26D, US3, 10B   | US26D, US3, 10B   | US26D, US3, 10B   | US26D, US3, 10B                     | US26D, US3, 10B                     | US26D, US3, 10B   | US26D, US3, 10B   | US26D, US3, 10B  | US26D, US3, 10B  | US26D, US3, 10B  | US26D, US3, 10B  | US26D, US3, 10B  | US26D, 10B  | US26D, 10B  |

**LEGEND:**

Privacy -       Narrow Stile -       Network Wireless -       Double-Sided -       Keypads -

(Note: Also see ordering information charts pg. 13)

# Control Locks & Special Application Models

| DL6500                              | PDL6500                             | PDL7100   | DL1200  | DL1300  | PDL1300   | ETDL  | ETPDL   | ETDLN   | ETPDN   | DL1200ET  | DL1300ET  | PDL1300ET   | DK3000               | PDK3000                 | NETDKPAK  | NETPDKPAK   |
|-------------------------------------|-------------------------------------|---|---|---|---|---|---|---|---|---|---|---|----------------------|-------------------------|---|---|
| Mortise 802.11 Ethernet             | Mortise Prox 802.11 Ethernet        | Cylindrical Prox 802.11 Ethernet  | Narrow Stile  | Narrow Stile  | Narrow Stile Prox   | For use w/ panic device   | For use w/ panic device ,Prox   | For use w/ panic device 802.11 Ethernet   | For use w/ panic device ,Prox, 802.11 Ethernet  | Narrow Stile For use w/ panic device                                      | Narrow Stile For use w/ panic device                                      | Narrow Stile For use w/ panic device, Prox                                | Standalone Keypad    | Standalone Keypad, Prox | Keypad 802.11 Ethernet  | Keypad, Prox 802.11 Ethernet  |
| 5,000                               | 5,000                               | 5,000   | 100   | 2000  | 2000  | 2000  | 2000  | 2000  | 2000  | 100   | 2000  | 2000  | 2000                 | 2000                    | 5,000   | 5,000   |
| 3-6 digits                          | 3-6 digits                          | 3-6 digits  | 3-6 digits  | 3-6 digits  | 3-6 digits  | 3-6 digits  | 3-6 digits  | 3-6 digits  | 3-6 digits  | 3-5 digits  | 3-6 digits  | 3-6 digits  | 3-6 digits           | 3-6 digits              | 3-6 digits  | 3-6 digits  |
| Keypad /PC                          | Keypad /PC                          | Keypad /PC  | Keypad  | Keypad /PC  | Keypad /PC  | Keypad /PC  | Keypad /PC  | Keypad /PC  | Keypad /PC  | Keypad  | Keypad /PC  | Keypad /PC  | Keypad /PC           | Keypad /PC              | Keypad /PC  | Keypad /PC  |
| All metal, 12 button                | All metal, 12 button                | All metal, 12 button  | All metal, 12 button  | All metal, 12 button  | All metal, 12 button  | All metal, 12 button  | All metal, 12 button  | All metal, 12 button  | All metal, 12 button  | All metal, 12 button  | All metal, 12 button  | All metal, 12 button  | All metal, 12 button | All metal, 12 button    | All metal, 12 button  | All metal, 12 button  |
| Straight or curved lever            | Straight or curved lever            | Straight or curved lever  | Straight or curved lever, thumbturn or knob                               | Straight or curved lever, thumbturn or knob                               | Straight or curved lever, thumbturn or knob                               | Straight or curved lever  | Straight or curved lever  | Straight or curved lever  | Straight or curved lever  | Straight or curved lever, thumbturn or knob                               | Straight or curved lever, thumbturn or knob                               | Straight or curved lever, thumbturn or knob                               |                      |                         | Straight or curved lever  | Straight or curved lever  |
| 35,000                              | 35,000                              | 35,000  |   | 40000   | 40000   | 40000   | 40000   | 35,000  | 35,000  |   | 40000   | 40000   | 40000                | 40000                   | 35,000  | 35,000  |
| 500                                 | 500                                 | 500   |   | 500   | 500   | 500   | 500   | 500   | 500   |   | 500   | 500   | 500                  | 500                     | 500   | 500   |
|                                     | Prox HID                            | iClass HID Prox / 13.56MHz  |   |   | Prox HID  |   | Prox HID  |   | Prox HID  |   |   | Prox HID  |                      | Prox HID                |   | Prox HID  |
| Global lockdown                     | Global lockdown                     | Global lockdown   |   |   |   |   |   | Global Lockdown   | Global lockdown   |   |   |   |                      |                         | Global lockdown   | Global lockdown   |
|                                     |                                     |   |   |   |   |   |   |   |   |   |   |   |                      |                         |   |   |
| Standard                            | Standard                            | Standard  | Standard  | Standard  | Standard  | Standard  | Standard  | Standard  | Standard  | Standard  | Standard  | Standard  | Standard             | Standard                | Standard  | Standard  |
| Handed; Field Reversible            | Handed; Field Reversible            | Nonhanded   | Nonhanded   | Nonhanded   | Nonhanded   | Nonhanded.  | Nonhanded.  | Nonhanded.  | Nonhanded.  | Nonhanded   | Nonhanded   | Nonhanded   |                      |                         | Nonhanded   | Nonhanded   |
| 1-5/8 to 1-7/8"                     | 1-5/8 to 1-7/8"                     | 1-5/8 to 1-7/8" others upon request                                     | 1-3/4"  | 1-3/4"  | 1-3/4"  | 1-5/8 to 1-7/8" (others on request.)  | 1-5/8 to 1-7/8" (others on request.)  | 1-5/8 to 1-7/8" (others on request.)  | 1-5/8 to 1-7/8" (others on request.)  | 1-3/4"  | 1-3/4"  | 1-3/4"  |                      |                         | 1-5/8 to 1-7/8" others upon request                                     | 1-5/8 to 1-7/8" others upon request                                     |
| 2-3/4" (included)                   | 2-3/4" (included)                   | 2-3/4" (included) 2-3/8" opt.   | 31/32", 1-1/8", 1-1/2"  | 31/32", 1-1/8", 1-1/2"  | 31/32", 1-1/8", 1-1/2"  |   |   |   |   | 31/32", 1-1/8", 1-1/2"  | 31/32", 1-1/8", 1-1/2"  | 31/32", 1-1/8", 1-1/2"  |                      |                         | 2-3/4" (included) 2-3/8" opt.   | 2-3/4" (included) 2-3/8" opt.   |
| Generic mortise cylinder, supplied. | Generic mortise cylinder, supplied. | Large key-in-knob, incld -or- IC Prep for Best/Falcon/Arrow (w/o cyld.) | Generic 1-1/4" mortise cylinder, supplied. 1-1/8", 1-1/4"1-3/8" supported | Generic 1-1/4" mortise cylinder, supplied. 1-1/8", 1-1/4"1-3/8" supported | Generic 1-1/4" mortise cylinder, supplied. 1-1/8", 1-1/4"1-3/8" supported | Generic Rim Cylinder, supplied. Other mfrs. Cylinder Adapters must be ordered separately. | Generic Rim Cylinder, supplied. Other mfrs. Cylinder Adapters must be ordered separately. | Generic Rim Cylinder, supplied. Other mfrs. Cylinder Adapters must be ordered separately. | Generic Rim Cylinder, supplied. Other mfrs. Cylinder Adapters must be ordered separately. | Generic 1-1/4" mortise cylinder, supplied. 1-1/8", 1-1/4"1-3/8" supported | Generic 1-1/4" mortise cylinder, supplied. 1-1/8", 1-1/4"1-3/8" supported | Generic 1-1/4" mortise cylinder, supplied. 1-1/8", 1-1/4"1-3/8" supported |                      |                         | Large key-in-knob, incld -or- IC Prep for Best/Falcon/Arrow (w/o cyld.) | Large key-in-knob, incld -or- IC Prep for Best/Falcon/Arrow (w/o cyld.) |
|                                     |                                     | Yale, Medeco, Sargent, Corbin/ Russwin, Schlage                         | Yale, Medeco, Corbin/ Russwin, Schlage                                    | Yale, Medeco, Corbin/ Russwin, Schlage                                    | Yale, Medeco, Corbin/ Russwin, Schlage                                    |   |   |   |   | Yale, Medeco, Corbin/ Russwin, Schlage                                    | Yale, Medeco, Corbin/ Russwin, Schlage                                    | Yale, Medeco, Corbin/ Russwin, Schlage                                    |                      |                         | Yale, Medeco, Sargent, Corbin/ Russwin, Schlage                         | Yale, Medeco, Sargent, Corbin/ Russwin, Schlage                         |
| yes                                 | yes                                 | yes   |   |   |   | yes   | yes   | yes   | yes   |   |   |   | yes                  | yes                     | yes   | yes   |
| 4 C cells 5 years 500,000           | 4 C cells 5 years 500,000           | 4 C cells 5 years 500,000   | 2-3V Lithium, 100,000   | 2-3V Lithium, 80,000  | 2-3V Lithium, 65,000  | 5AA; 60000  | 5AA; 60000  | 4 C cells 5 years 500,000   | 4 C cells 5 years 500,000   | 2-3V Lithium, 100,000   | 2-3V Lithium, 80,000  | 2-3V Lithium, 65,000  |                      |                         | 4 C cells 5 years 500,000   | 4 C cells 5 years 500,000   |
| 3 Hr Fire Rated UL                  | 3 Hr Fire Rated UL                  | BHMA Grade 1 Lockset; 3hr. Fire Rated UL                                |   |   |   |   |   |   |   |   |   |   | UL                   | UL                      | Pending   | Pending   |
| US26D, 10B                          | US26D, 10B                          | US26D, 10B  | US10B, US26D, MS, MB  | US10B, US26D, MS, MB  | US10B, US26D, MS, MB  | US26D, US3, 10B   | US26D, US3, 10B   | US26D, US3, 10B   | US26D, US3, 10B   | US10B, US26D, MS, MB  | US10B, US26D, MS, MB  | US10B, US26D, MS, MB  | US10B, US26D, MS, MB | US10B, US26D, MS, MB    | US26D, 10B  | US26D, 10B  |



# K-12 and Campus Security LocDown™ Solutions:



Everyone involved in schools, from parents, students and teachers to administrators and facility managers, are actively looking for expert solutions and actionable steps to secure their K-12 or college/university. And, you can be that expert provider. Better access control is one of the best steps you can offer and they can truly use today – right now. Here are some of our tiered solutions for any application & budget.

## Electronic Standalone Locking Solutions w/ Local Lock Down



### Alarm Lock Trilogy P/DL 4100/4500 Series

- Simple push button locks door from inside, or use keyfob
- Activates small light indicators on front & back sides of door
- Includes bilingual signage on use and lock down
- Override option by authorized administrators
- No keys, key hassles; access controlled with ID card or digital code (overridden in lockdown emergency)
- 1 Hours installation. Can be field converted into Wireless Network Locks later with kit (as below)
- Grade 1 Durable, Vandal-Resistant All Metal Locks, for inside & outdoors

## Electronic Standalone Locking Solutions w/ Keyfob & Panic Button Lock Down



### Trilogy Locks with Keyfob &/or Panic Option

Lock down classrooms, offices, common areas, labs from safely inside, with the press of a button

- Rugged, easy to use and install electronic Trilogy locks add access convenience & quickly retrofit any lockset on virtually any door, inside or out.
- Easily add new keyfob or panic button option to most new & existing Trilogys (3000 Series & above) and program to control "Lock Down" or "Remote Release" with one button.
- No keys, or liability from lost or misappropriated keys, or distribution hassles; access is controlled with ID card or digital PIN code
- 1 Hour installation. Can be field converted into Wireless Network Locks later with kit (as below)

## Wireless Network Locking Solutions w/ Global Lock Down



### Trilogy® Networx™ P/DL6100, 6500, 7100 Series

Global Lockdown activated from the server or any individual access lock, in under 10 seconds

- Deploy wireless networked access locks in under an hour
- ID Card and/or Digital Code Access (PIN)
- Real-time global lockdown or unlock in under 10 seconds
- Scalable by door, area, building or across a campus of buildings, new & legacy
- Manage on-premises or remotely via web client or smart device– Control access, privileges, locks and doors, by time schedule, exception, etc.
- Grade 1 Durable, Unparalleled battery life, 5 years+

## Small Access System w/ Global Lock Down



### Networx NetPanel & Wireless Keypad Solution

Affordable Access System w/ Global Lock Down

- Supports up to 5 thousand PIN-code or ID card users.
- Controls electric strike, Mag Lock or exit device with electric latch retraction (ex. narrow stile glass doors).
- Operates 1 or 2 Networx Keypads, PIN-code or PIN & Prox ID or supports standard Wiegand output Prox Readers.
- Inputs for Door-Position Switch and/or Remote Release
- Includes, rechargeable battery backup, 1.5amp power supply, & plug in AC transformer.
- Top features: Global lockdown and passage from keypad or PC; schedules; 35K event log, request-to-exit, door ajar/kick-in, etc.
- Kits with Networx keypads or NetPanel only



**SAVI™, the Security Access-Control Vulnerability Index™ is what we created for security professionals to use as an objective, brand-agnostic audit tool to evaluate any school's access control vulnerability.** You simply survey what kinds of security they have in place, and SAVI automatically calculates a score for them now. Then you use that to create a plan of actionable next-steps you can suggest and deploy, to improve their security and SAVI score, ranging from adding ballistic glass or better gates, to classroom intruder- or standalone digital access

-locks with lockdown function or keyfobs. Or, from adding networked wireless locks with near-instantaneous global lockdown, to implementing an access control systems for a few doors to many, in real time.

**Become a certified SAVI professional.** We'll show you how. You'll learn how to market, approach and make a positive impact in the educational market that so desperately needs objective answers and your expertise. Call us 1-800-ALA-LOCK for training today or email SAVI@alarmlock.com.

# About Us

**Alarm Lock Systems, Inc.** is a respected leader in the design and manufacture of commercial door technology solutions for over four decades, specializing in access and egress solutions for education, healthcare, government, airports, corporations and mixed-use environments. Its popular Trilogy® line enables professionals securing buildings of all kinds to more cost-effectively and quickly add dependable coded or ID-carded wireless access control a door at a time, with a dependable field-proven access solution and a consistent model for every door type in a facility (cylindrical, mortise, narrow stile/glass, privacy or double-sided).

Trilogy® electronic access control locks, include original standalone digital and Prox models, with built-in HID® Prox reader, and next-gen. wireless networking Trilogy Network™ access locks, featuring global lockdown in seconds and the elimination of door-to-door programming and audit trail event queries by communicating wirelessly via ethernet or 802.11. Blending with even the most demanding decor, ArchiTech™ Network Series are customizable with hundreds of trims, finishes, and reader designs for the ideal architecturally-elegant access solution. All Trilogys feature the same rugged dependability, tool-free keypad programming and unsurpassed long battery life, with cylindrical models boasting Grade 1 BHMA certification. Alarm Lock Network™ Prox ID and PIN Code Keypads and NetPanel 2-Door Access Controller provide a wireless keypad solution for use with magnetic locks, strikes and electrified exit devices. All programmable Alarm Lock models share the same database, programming, scheduling and functionality and use Alarm Lock's Free Windows-based software. Many models can also be integrated within an enterprise security system platform, in real-time, as a single-door controller on ContinentalAccess® CA3000 and as a Lenel® Open Access Integration Partner.

CardAccess® 3000 

## Grow with Alarm Lock's Profit Center Program

Today's electronic pushbutton locks offer considerable security, key-free consumer convenience and ease of retrofitting standard door locks. Add to that more stringent security needs, virtually everywhere, and the result has been that installations of standalone access control locks, with and without door-usage logging, are increasingly in demand, with no end or slow down in sight. For those eager to enter this lucrative, booming market and expand and complement their traditional offerings, Alarm Lock, the leader in electronic pushbutton access locks, has specially designed a program for retail locksmiths to tap this potential and grow their business.

The Alarm Lock Profit Center Program offers retail locksmiths and their technicians FREE simple, step-by-step, field-proven methods. Trained professionals teach and guide locksmith/dealers exactly how to install, sell and compete effectively in this marketplace. Your technicians will become expert on the product, its application and its marketing, through our comprehensive system of training seminars, joint sales calls and presentations to your customers! In simplest terms, we've designed a program that will help you secure and grow your bottom line with us. To enroll in our Free "Profit Center Program" just contact your Alarm Lock Sales Representative at 1-800-ALA-LOCK.

## Alarm Lock Training Classes are available locally in the field nationwide and online

Get training for you and your staff on using the latest new technology, installation & programming techniques, growth in new markets and even earn factory-certification on Alarm Lock products from Trilogy Standalone Locks, to Wireless Networked Networkx Locks, Gateways and our NetPanel. All Alarm Lock Classes are hands-on classes taught with real-world applications and locking expertise.

**Online Webinar classes** can be taken right from your computer: No gas or travel required, and optionally, continuing ed. credits, without ever leaving your office. They are presented live, and each is followed by a Question & Answer Session.

**Previously-Recorded Webinars** are available when you are, ideal as a refresher too, 24/7.

**For the complete class schedule and to register go to [www.alarmlock.com/seminars](http://www.alarmlock.com/seminars)**







**Alarm Lock is a leader in access and egress solutions for education, healthcare, government, retail, airports & industry.** Field-proven standalone Trilogy® electronic keyless access locks, provide access control with PIN-code or built-in HID® Prox reader for ID badges. Next-gen. wireless Trilogy Networkx™ access locks, have the added benefit of eliminating door-to-door operations and featuring global lockdown or unlock in seconds, activated from any lock or the computer network's server. New ArchiTech™ Networkx Series take it a step farther with hundreds of customizable trims, finishes, and readers for the ideal architecturally-elegant access solution. Both lines feature keyfob and remote button support; plus free Windows-based software and models for every application & budget.



**ALARM LOCK**

345 Bayview Avenue Amityville, NY 11701 USA • 1-800-ALA-LOCK 631-789-4871 Fax: 631-789-3383 • [www.alarmlock.com](http://www.alarmlock.com)

Alarm Lock Systems, Inc. is a Division of NAPCO Security Technologies, Inc. • NAPCO • ALARM LOCK • CONTINENTAL ACCESS • MARKS

Trilogy® is a registered trademark of Alarm Lock. Sirenlock, Trilogy Networkx ArchiTech and SAVI / School Access-Control Vulnerability Index and ContinentalAccess are trademarks of Alarm Lock/Napco. HID® and Lenel® are trademarks of their respective companies. © Alarm Lock, 2015. Specifications subject to change. Pats & Pats. Pending. ALA1125